

REFRIGERATION

WCM1400WE WCM2000WE WCM3000WE
WCM5000WE WCM7000WE

CONGRATULATIONS

Congratulations and thank you for choosing our Westinghouse chest freezer. We are sure you will find your new appliance a pleasure to use. Before you use the appliance, we recommend that you read through the whole user manual which provides a description of the product and it's functions.

To avoid the risks that are always present when you use an appliance, it is important that the appliance is installed correctly and that you read the safety instructions carefully to avoid misuse and hazards.

We recommend that you keep this instruction booklet for future reference and pass it on to any future owners.

After unpacking the appliance, please check it is not damaged. If in doubt, do not use the appliance but contact your local customer care centre.

For contact details, refer to the last page of this user manual.

Conditions of use

This appliance is designed and intended to be used in normal domestic applications only.

Please ensure you read the instruction manual fully before you call for service, or a full service fee could be applicable.

Record model and serial number here:

Model number:.....

Serial number:.....

PNC:.....



WARNING

This symbol indicates information concerning your personal safety.



CAUTION

This symbol indicates information on how to avoid damaging the appliance.



WARNING

When positioning the appliance, ensure the supply cord is not trapped or damaged.

Do not locate multiple portable socket-outlets or portable power supplies at the rear of the appliance.



Risk of fire / flammable materials

CONTENTS

Important safety instructions.....	3
Features of your freezer	4
Transportation instructions.....	6
Installing your new appliance.....	6
Using your appliance.....	7
Defrosting your appliance	7
Cleaning your appliance.....	8
Troubleshooting.....	9
Do's and don'ts	10
Warranty.....	11



IMPORTANT

Important - check for any damages or marks.

If you find the refrigerator/freezer is damaged or marked, you must report it within 7 days if you wish to claim for damage/marks under the manufacturers warranty. This does not affect your statutory rights.



ENVIRONMENT

Information on disposal for users

- Most of the packing materials are recyclable. Please dispose of those materials through your local recycling depot or by placing them in appropriate collection containers.
- If you wish to discard this product, please contact your local authorities and ask for the correct method of disposal.



IMPORTANT

This symbol indicates tips and information about use of the appliance.



ENVIRONMENT

This symbol indicates tips and information about economical and ecological use of the appliance.

IMPORTANT SAFETY INSTRUCTIONS

Please read the user manual carefully and store in a handy place for later reference. Pass the user manual on to possible new owners of the appliance.

Read the following carefully to avoid damage or injury.

NOTE: You must read these warnings carefully before installing or using the appliance. If you need assistance, contact your Customer Care Department. The manufacturer will not accept liability, should these instructions or any other safety instructions incorporated in this book be ignored.

Children and vulnerable people safety.



WARNING

- When you dispose of your old refrigerators and freezers, remove any doors. Children can suffocate if they get trapped inside.
- This appliance is not intended for use by persons (including children) with reduced physical, sensory or mental capabilities, or lack of experience and knowledge, unless they have been given supervision or instruction concerning use of the appliance by a person responsible for their safety.
- Children should be supervised to ensure that they do not play with the appliance.
- Do not use mechanical devices or other means to accelerate the defrosting process other than those recommended by the manufacturer.
- This appliance contains insulation formed with flammable blowing gases. Avoid safety hazards by carefully disposing of this appliance.
- The appliance must be plugged into its own dedicated 220-240V, 50Hz AC electrical outlet.
- The plug must be accessible when the freezer is in position.
- It is essential that the power point is properly earthed to ground. Consult a qualified electrician if you are unsure.
- Don't use extension cords or adapter plugs with this freezer.
- If the power cord is damaged, it must be replaced by the manufacturer, its service agent or similarly qualified persons in order to avoid a hazard.
- Unplug the freezer before cleaning to avoid electric shock.



CAUTION

- Never unplug the freezer by pulling the electrical cord as this may damage it. Grip the plug firmly and pull straight out.
- Choose a location for your freezer that isn't too cold. The ambient room temperature should be above 10°C.
- Stand your freezer in a dry place – avoid areas of high moisture or humidity.

- Don't put the freezer in frosty or unprotected areas.
- Keep the freezer out of direct sunlight.
- Don't locate the freezer near stoves, fires or heaters.

When installed correctly, your freezer should:

- Have adequate space at the back and sides for air circulation.
- Be aligned to the surrounding cupboards.
- When positioning your appliance take care not to damage your flooring, pipes, wall coverings etc.
- Do not move the appliance by pulling by the lid or handle.
- Do not store explosive substances such as aerosol cans with a flammable propellant in this appliance.



WARNING

If pressurised aerosol containers bear the word 'flammable' and/or a small flame symbol, do not store them inside any refrigerator or freezer. If you do so you may cause an explosion.



WARNING

R600a refrigerant warning

This appliance contains flammable R600a refrigerant. Avoid safety hazards by carefully installing, handling, servicing and disposing of this appliance.

- Ensure that the tubing of the refrigerant circuit is not damaged during transportation and installation.
- Leaking refrigerant may cause eye injuries or ignite.
- The room for installing appliance must be at least 1m³ per 8g of refrigerant. The amount of refrigerant charged in the appliance can be found on the rating plate on the back of the appliance.
- If you are unsure of the refrigerant type, check the rating plate on the back of the appliance.
- Keep ventilation openings in the appliance enclosure or in the built-in structure, clear of obstruction.
- Do not use electrical appliances inside the food storage compartments of the appliance, unless they are of the type recommended by the manufacturer.
- It is hazardous for anyone other than an Authorised Service Person to service this appliance. In Queensland Australia the Authorised Service Person MUST hold a Gas Work Authorisation for hydrocarbon refrigerants, to carry out servicing or repairs which involve the removal of covers.
- Do not damage the refrigerant circuit.

FEATURES OF YOUR FREEZER

(WCM1400WE & WCM2000WE & WCM3000WE)

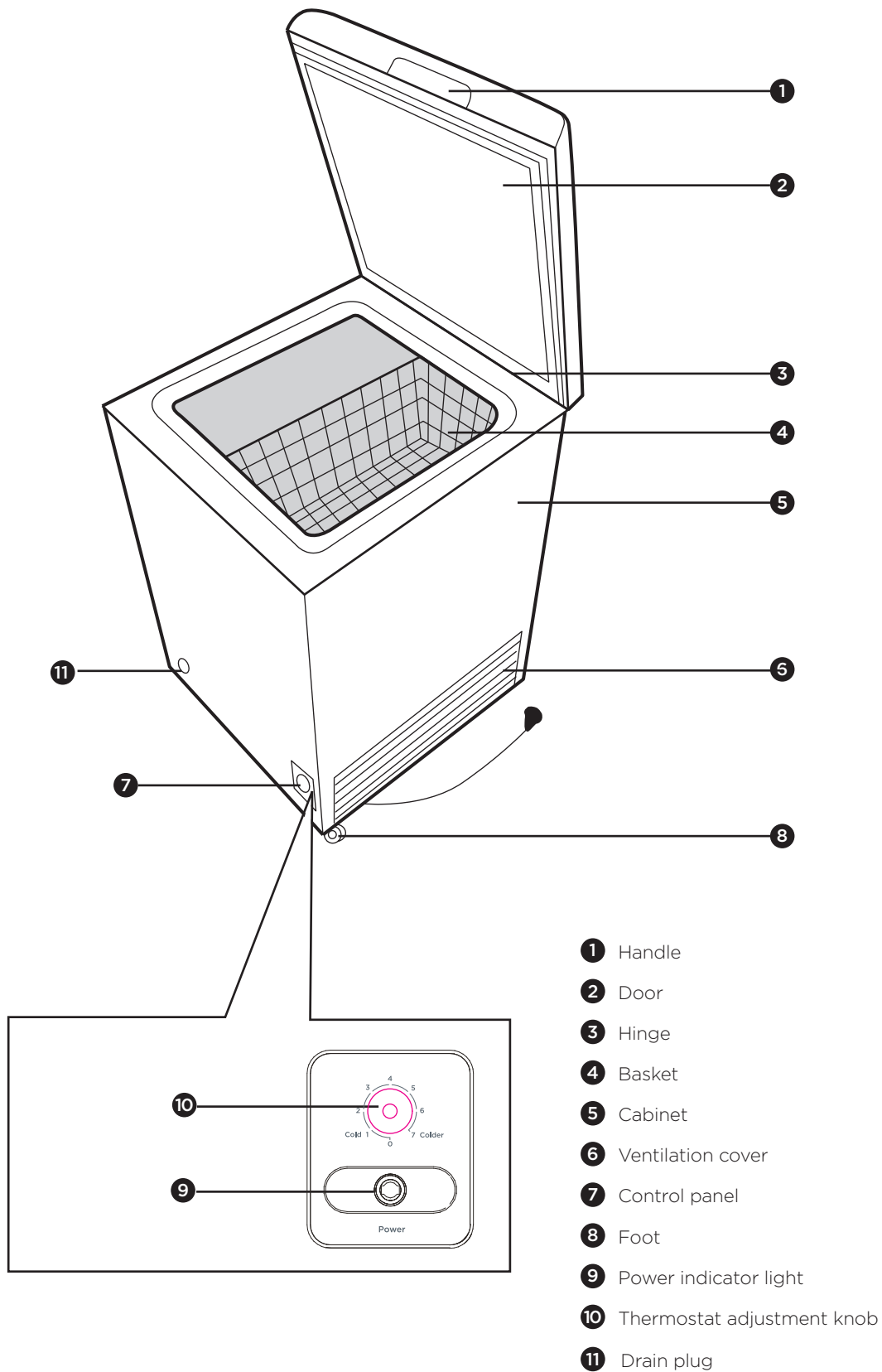

FEATURES OF YOUR FREEZER

(WCM5000WE & WCM7000WE)

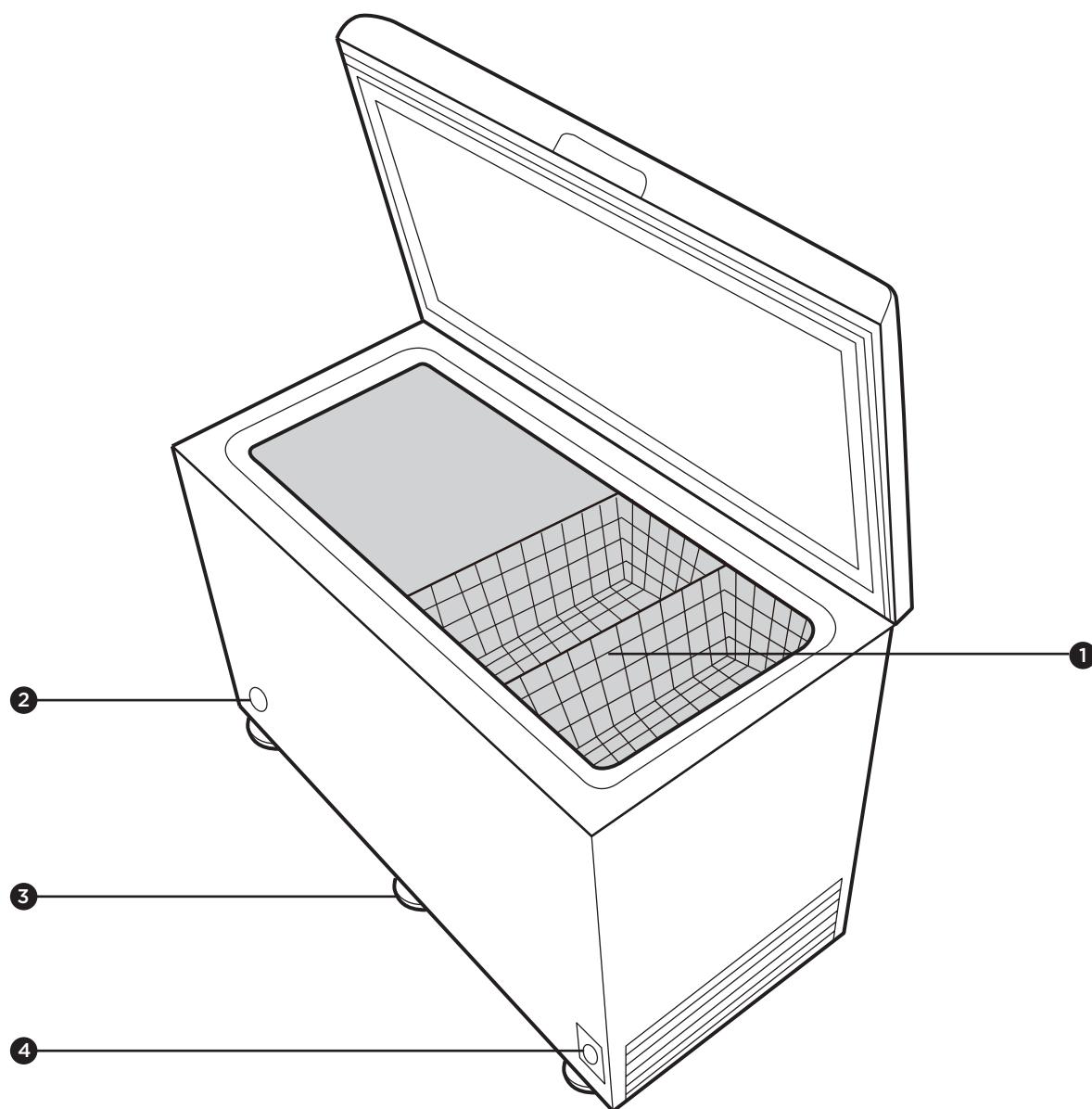

- ❶ Basket
- ❷ Drain plug
- ❸ Wheel
- ❹ Thermostat Control

TRANSPORTATION

The appliance should be transported only in a vertical upright position. The packing as supplied must be intact during transportation.



CAUTION

- Failure to comply with the above instructions could result in damage occurring to the appliance.
- The manufacturer will not be held responsible if these instructions are disregarded.
- The appliance must be protected against rain, moisture and other atmospheric influences.

INSTALLING YOUR NEW APPLIANCE

If possible avoid placing the appliance near cookers, radiators or in direct sunlight as this will cause the compressor to run for long periods. If installed next to a source of heat or freezer, maintain the following minimum side clearances:

- From cookers 100 mm
- From radiators 300 mm
- From fridges 100 mm

Make sure that sufficient room is provided around the appliance to ensure free air circulation. Ideally, a space of no less than 100mm must be left around the freezer, and ensure you allow gaps as shown in the diagram below.

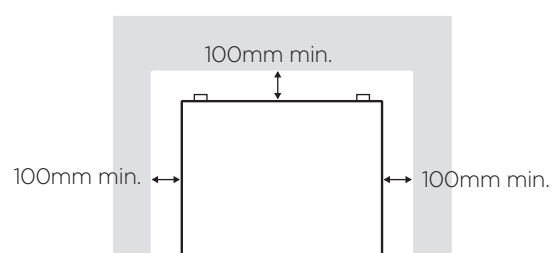

Refer to "Cleaning" section on page 8 to prepare your appliance for use.

If the freezer is installed in unheated areas (garages etc.), in cold weather condensation may form on the outer surfaces. This is quite normal and is not a fault. Remove the condensation by wiping with a dry cloth.

USING YOUR NEW APPLIANCE

Before you begin

Before you start to use the freezer:

1. Check that the interior is dry.
2. Clean the interior as recommended under "Cleaning" on page 6.
3. Insert the plug into the wall socket and switch on the electricity supply. The red power light will now be on. Avoid accidental disconnection by taping over the switch.

NOTE: You will hear a noise as the compressor starts up. The liquid and gases sealed within the refrigeration system may also give rise to noise, whether the compressor is running or not, which is quite normal.



IMPORTANT

Do not load the appliance immediately after it is switched on. Wait until the correct storage temperature has been reached.

Adjusting the temperature

The temperature of the freezer is adjusted by means of the knob assembled on the thermostat. "1, 2, 3, 4 & 7" do not represent a specific temperature. The smaller the number the higher the temperature. Position "7" is coldest temperature setting.

Thermostat adjustment knob

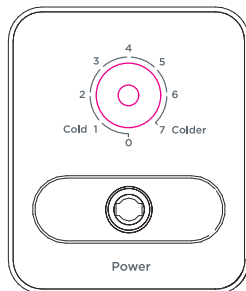

When you first start using your freezer set the control to 4, this is correct for most freezing and storing needs. However, the control setting can be adjusted if required. (Turn clockwise for colder temperatures). You should only make small adjustments and wait 24 hours to see whether you need to make further changes.

Please remember each time the lid is opened, cold air escapes and the internal temperature rises. Therefore never leave the lid open and ensure it is closed immediately after food is put in or removed.

Green indicator light

The green indicator light set is on the front side of the freezer for easy visibility. When illuminated this means that the compressor is operating and the appliance is cooling. If the compressor is operating and the indicator light is not on, call for service.

Storing frozen food

Prepackaged commercially frozen food should be stored in accordance with the frozen food manufacturer's instructions.

To ensure that the high quality achieved by the frozen food manufacturer and the food retailer is maintained the following should be remembered:

- Put packets in the freezer as quickly as possible after purchase.
- Do not exceed "Use By", "Best Before" dates on the packaging.

Freezing fresh food

- Place fresh food to be frozen near the side walls to ensure fast freezing and away from already frozen food, if possible.
- Never exceed the maximum storage capacity of the freezer as displayed on the rating plate.
- The quality of the food is best preserved when it is frozen right through to the centre as quickly as possible.
- Take special care not to mix already frozen food and fresh food.

Defrosting

Since the main purpose of your freezer is to preserve food, it should be kept clean at all times. Your freezer should be defrosted when ice is approximately 6 mm thick; otherwise it will interfere with efficient operation and reduce storage capacity. To ensure hygiene and efficiency, complete defrosting is recommended AT LEAST twice each year, preferably when food supply is low.

1. 6 hours before defrosting, please set the thermostat knob to the "Coldest" position to make sure the food is at the lowest temperature when you get it out.
2. Switch off power to freezer at power outlet and remove cord.
3. Remove frozen food, wrap in newspaper and place in a cool place. Very small items and ice cream should be placed in another freezer if possible.
4. Remove the freezer basket. Leave the lid open. Containers of warm water may be placed carefully in the freezer to speed up the defrosting process.

USING YOUR NEW APPLIANCE

WARNING

Never use hairdryers, electrical heaters or other such electrical appliances for defrosting.

5. Lift out the rubber plug from the internal drain hole inside the freezer (Figure 1).

NOTE: please keep the rubber cover in a safe place during defrosting and put it back after defrosting is done.

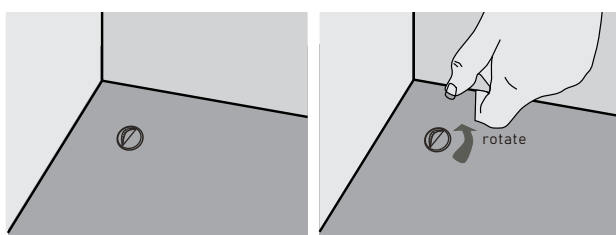

Figure 1

6. Pull out the external water drain by 20-25mm until the water hole can be seen.
7. Twist the external water drain until the water hole points downward.



Figure 2

8. After defrosting is complete and all of the water has drained, wipe the freezer out with a damp cloth and dry, ensuring the freezer inner surfaces are dry before reloading frozen food. Water in the freezer can cause food to stick to liner when frozen.
9. Rotate the external water drain until the water hole points up and push it back into place (Figure 3).
10. Replace the internal drain plug (Figure 1).
11. Plug the freezer back in and turn it on, reload food to be frozen.

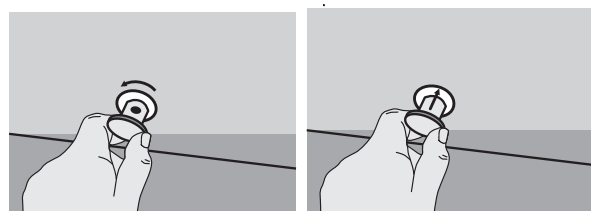

Figure 3

CAUTION

Do not use pointed or sharp-edged objects such as knives or forks to remove the frost.

CLEANING YOUR NEW APPLIANCE

Cleaning

WARNING

Unplug the freezer before cleaning to avoid electric shock.

Interior

The interior should be cleaned when defrosting. Any spilled food should be wiped up thoroughly and promptly.

Exterior

It is a good idea to polish the exterior about once a year with a high-grade wax like the one you use with your car. After that, an occasional wipe over with a clean, damp cloth will help remove finger-marks.

NOTE: Do not wax plastic parts or decorative trim. Wash these in warm (not hot) water and use an unscented detergent. Avoid getting water on controls. Avoid scouring pads, abrasive powders, metal polishes, aerosol cleaners, methylated spirits and other solvents as they could damage the easy to clean glossy surfaces.

TROUBLESHOOTING

What to do before calling for service

Here are some easy checks you can make yourself before you call for service. You may easily locate the problem and save yourself the inconvenience, time, and money of a service call.

PROBLEM	SOLUTION
Freezer is not operating	Check that the cord is plugged into the outlet properly and that the outlet is switched "on".
	Check with another appliance or lamp to see if the outlet has electrical supply.
	Try adjusting the temperature control to a slightly "colder" position.
If there are odours inside the freezer	The interior may need cleaning.
	Some foods produce odours and should be covered.
	Some containers and wrapping can cause odours.
	Ask yourself if the odour started about the same time you started storing something unusual.
The lid will not close	Check the storage level of frozen food.
Temperature on the outside and rear side of the freezer is hot/warm	In normal operation, the freezer transfers heat from inside to outside of the cabinet. It is normal for the side and rear of the freezer to feel warm/hot while operating. This will be more noticeable during start up and hot ambient conditions.
Power failure (due to the failure of external power supply)	Do not open the lid. Frozen food should not be affected if the failure lasts for less than 20 hours. If the power is unavailable for longer, then the food should be removed and eaten immediately or discarded.

DO'S AND DON'TS

DO

Defrost food from the freezer thoroughly in a fridge or in a microwave oven following defrosting and cooking instructions.

Ensure that chest freezer lid is completely closed after each use.

Close the lid gently.

Check contents of the freezer at regular intervals.

Clean and defrost your freezer regularly (See "Defrosting").

Keep food for as short a time as possible and adhere to "Best Before", "Use By" dates.

Store commercially frozen food in accordance with the instructions given on the packets that you buy.

Always choose high quality fresh food and be sure it is thoroughly clean before you freeze it.

Prepare fresh food for freezing in small portions to ensure rapid freezing.

Wrap all foods in aluminum foil or freezer quality plastic bags and make sure any air is excluded.

Wrap frozen food when you buy it and put it in to the freezer as soon as possible.

Store small items in the basket provided.

Remove ice cream from the freezer 10-20 minutes before serving.

Defrost frozen meat completely before cooking.

DON'T

Leave the lid open for long periods as this will make the freezer more costly to run and cause excessive ice formation.

Use pointed sharp edged objects such as knives, forks to remove the ice.

Put hot food in the freezer. Let it cool down first.

Put liquid-filled bottles or sealed cans containing carbonated liquids into the freezer as they may burst.

Store poisonous or dangerous substances in the freezer. Your freezer has been designed for the storage of edible foodstuffs only.

Electrolux Warranty

FOR SALES IN AUSTRALIA AND NEW ZEALAND
APPLIANCE: WESTINGHOUSE REFRIGERATORS AND FREEZERS

This document sets out the terms and conditions of the product warranties for Westinghouse Appliances. It is an important document. Please keep it with your proof of purchase documents in a safe place for future reference should there be a manufacturing defect in your Appliance. This warranty is in addition to other rights you may have under the Australian Consumer Law.

1. In this warranty:

- (a) 'ACL' or 'Australian Consumer Law' means Schedule 2 to the Competition and Consumer Act 2010;
- (b) 'Appliance' means any Electrolux product purchased by you and accompanied by this document;
- (c) 'ASC' means Electrolux's authorised serviced centres;
- (d) 'Westinghouse' is the brand controlled by Electrolux Home Products Pty Ltd of 163 O'Riordan Street, Mascot NSW 2020, ABN 51 004 762 341 in respect of Appliances purchased in Australia and Electrolux (NZ) Limited (collectively "Electrolux") of 3-5 Niall Burgess Road, Mount Wellington, in respect of Appliances purchased in New Zealand;
- (e) 'Warranty Period' means the period specified in clause 3 of this warranty;
- (f) 'you' means the purchaser of the Appliance not having purchased the Appliance for re-sale, and 'your' has a corresponding meaning.

2. Application: This warranty only applies to new Appliances, purchased and used in Australia or New Zealand and is in addition to (and does not exclude, restrict, or modify in any way) other rights and remedies under a law to which the Appliances or services relate, including any non-excludable statutory guarantees in Australia and New Zealand.

3. Warranty Period: Subject to these terms and conditions, this warranty continues for in Australia for a period of 24 months and in New Zealand for a period of 24 months, following the date of original purchase of the Appliance. Specific components are warranted against manufacturing defects in Australia and New Zealand for the periods listed below;

- Compressor – Further 3 years
- External Condenser – Further 3 years
- Evaporator – Further 3 years
- Drier – Further 3 years

4. Repair or replace warranty: During the Warranty Period, Electrolux or its ASC will, at no extra charge if your Appliance is readily accessible for service, without special equipment and subject to these terms and conditions, repair or replace any parts which it considers to be defective. Electrolux may, in its absolute discretion, choose whether the remedy offered for a valid warranty claim is repair or replacement. Electrolux or its ASC may use refurbished parts to repair your Appliance. You agree that any replaced Appliances or parts become the property of Electrolux.

5. Travel and transportation costs: Subject to clause 7, Electrolux will bear the reasonable cost of transportation, travel and delivery of the Appliance to and from Electrolux or its ASC. Travel and transportation will be arranged by Electrolux as part of any valid warranty claim.

6. Proof of purchase is required before you can make a claim under this warranty.

7. Exclusions: You may not make a claim under this warranty unless the defect claimed is due to faulty or defective parts or workmanship. This warranty does not cover:

- (a) light globes, batteries, filters or similar perishable parts;
- (b) parts and Appliances not supplied by Electrolux;
- (c) cosmetic damage which does not affect the operation of the Appliance;
- (d) damage to the Appliance caused by:
 - (i) negligence or accident;
 - (ii) misuse or abuse, including failure to properly maintain or service;
 - (iii) improper, negligent or faulty servicing or repair works done by anyone other than an Electrolux authorised repairer or ASC;
 - (iv) normal wear and tear;
 - (v) power surges, electrical storm damage or incorrect power supply;
 - (vi) incomplete or improper installation;
 - (vii) incorrect, improper or inappropriate operation;
 - (viii) insect or vermin infestation;
 - (ix) failure to comply with any additional instructions supplied with the Appliance;

In addition, Electrolux is not liable under this warranty if:

- (a) the Appliance has been, or Electrolux reasonably believes that the Appliance has been, used for purposes other than those for which the Appliance was intended, including where the Appliance has been used for any non-domestic purpose;
- (b) the Appliance is modified without authority from Electrolux in writing;
- (c) the Appliance's serial number or warranty seal has been removed or defaced.

8. How to claim under this warranty: To enquire about claiming under this warranty, please follow these steps:

- (a) carefully check the operating instructions, user manual and the terms of this warranty;
- (b) have the model and serial number of the Appliance available;
- (c) have the proof of purchase (e.g. an invoice) available;
- (d) telephone the numbers shown below.

9. Australia: For Appliances and services provided by Electrolux in Australia: Electrolux goods come with guarantees that cannot be excluded under the Australian Consumer Law. You are entitled to a replacement or refund for a major failure and for compensation for any other reasonably foreseeable loss or damage. You are also entitled to have the Appliance repaired or replaced if the Appliance fails to be of acceptable quality and the failure does not amount to a major failure. 'Acceptable quality' and 'major failure' have the same meaning as referred to in the ACL.

10. New Zealand: For Appliances and services provided by Electrolux in New Zealand, the Appliances come with a guarantee by Electrolux pursuant to the provisions of the Consumer Guarantees Act, the Sale of Goods Act and the Fair Trading Act. Where the Appliance was purchased in New Zealand for commercial purposes the Consumer Guarantee Act does not apply.

11. Confidentiality: You accept that if you make a warranty claim, Electrolux and its agents including ASC may exchange information in relation to you to enable Electrolux to meet its obligations under this warranty.

Important Notice

Before calling for service, please ensure that the steps listed in clause 8 above have been followed.

AUSTRALIA	FOR SERVICE or to find the address of your nearest authorised service centre in Australia PLEASE CALL 13 13 49 <small>For the cost of a local call</small>	FOR SPARE PARTS or to find the address of your nearest spare parts centre in Australia PLEASE CALL 13 13 50 <small>For the cost of a local call</small>
NEW ZEALAND	FOR SERVICE or to find the address of your nearest authorised service centre in New Zealand PLEASE CALL 0800 10 66 10	FOR SPARE PARTS or to find the address of your nearest spare parts centre in New Zealand PLEASE CALL 0800 10 66 20

For more information on all Westinghouse appliances, or for dimension and installation information, call into your retailer, phone or email our customer care team or visit our website:

AUSTRALIA

phone: 1300 363 640

fax: 1800 350 067

email: customercare@electrolux.com.au

web: westinghouse.com.au

NEW ZEALAND

phone: 0800 436 245

fax: 0800 225 088

email: customercare@electrolux.co.nz

web: westinghouse.co.nz

TOP SERVICE

Top Service encompasses the after sales service provided by The Electrolux Group to consumers including delivery, home service and spare parts.

 and WESTINGHOUSE are trademarks of Westinghouse Electric Corporation. Used under license by Electrolux Home Products Pty Ltd. All Rights Reserved.

© 2016 Electrolux Home Products Pty Ltd.
ABN 51 004 762 341
WMAN_CF4_April2021