



# APPLIANCES FOR LIVING

**AFG999**

**AFG915**

**OPERATION MANUAL**

 **ARTUSI**  
THE ART OF LIVING



Congratulations, you are now the proud owner of an ARTUSI cooking appliance. Thank you for purchasing ARTUSI and welcome to the ARTUSI Family.

This instruction manual has been specially created to inform you of the full range of features your ARTUSI appliance has to offer and serves as an introduction to getting the very best out of your ARTUSI appliance.

We present detailed information on each of the features your ARTUSI appliance consists of. Once you have read this section you will be able to choose the most appropriate settings for your appliance when cooking different types of food.

We ask you to read the instructions in this booklet very carefully as this will allow you to get the best results from using your appliance. KEEP THE DOCUMENTATION OF THIS PRODUCT FOR FUTURE REFERENCE.

TO REGISTER YOUR PRODUCT WITH ARTUSI, PLEASE FILL OUT THE WARRANTY CARD AT THE END OF THIS BOOKLET AND POST IT TO: **REPLY PAID 83617**  
**LEICHHARDT NSW 2040**

Dear Artusi Customer, please read this user manual carefully before using the product and, keep it permanently at your disposal.

Note: This user manual is prepared for more than one model. Some of the features specified in this Manual may not be available on your appliance.

All our appliances are only for domestic use, not for commercial use. Products marked with (\*) are optional.

“THIS APPLIANCE SHALL BE INSTALLED IN ACCORDANCE WITH THE REGULATIONS FORCE AND ONLY USED IN A WELL VENTILATED SPACE. READ THE INSTRUCTIONS BEFORE INSTALLING OR USING THIS APPLIANCE”

“Conforms with the WEEE Regulations.”

## RECORD HERE FOR EASY REFERENCE

Model..... Colour.....

Serial Number..... Installation Date.....

Dealer's Name and Address.....

## WHEN YOU CALL FOR SERVICE

When you call for service or order parts for your unit, be sure to give:

1. MODEL
2. SERIAL NUMBER
3. COLOUR
4. PART NAME and/or description of problem
5. YOUR FULL NAME, ADDRESS, and HOME TELEPHONE NUMBER and BUSINESS TELEPHONE NUMBER IF APPROPRIATE.

Servicing shall be carried out only by authorised personnel.

## SECTION FOR THE QUALIFIED TECHNICIAN

## OVERALL DIMENSIONS

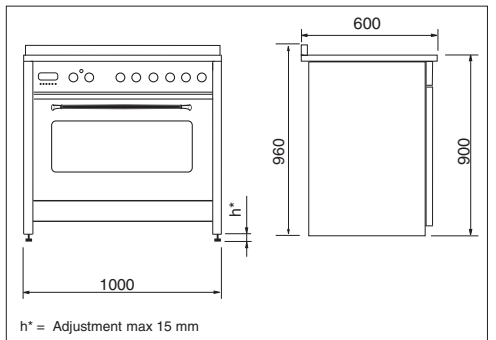
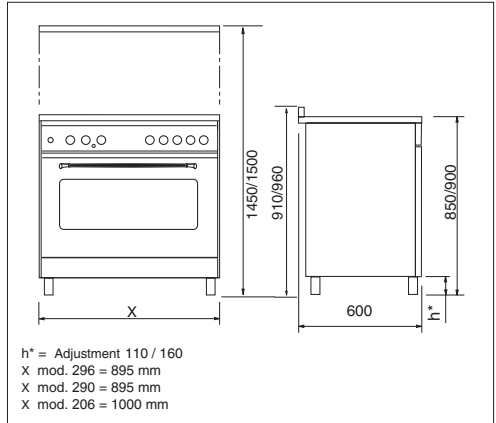

## INSTALLATION

### PROVISION FOR VENTILATION

The room where the Cooker is installed should have permanent ventilation as follows:

"Ventilation must be in accordance with AS/NZS 5601 - Gas Installations. In general, the appliance should have adequate ventilation for complete combustion of gas, proper flueing and to maintain temperature of immediate surroundings within safe limits."

Do not install in a bed-sitting room, a bathroom or shower room.

If there is another fuel burning appliance in the same room, a higher level of ventilation will be required, you should consult "the safety requirements".

In addition to the above, during prolonged use, opening a window in the same room is recommended. This will avoid the build up of excessive moisture and condensation.

## GENERAL INFORMATION

### ENVIRONMENTAL WARNING

#### Waste packaging

Do not throw the packaging of your appliance into the dustbin, but pick out the different materials (for instance foil, paperboard, polystyrene) according to the local rules for rubbish elimination.

This appliance must only be used for the purpose of domestic cooking.

### Getting to know your new cooker

Thank you for choosing one of our products. Our cookers are of simple, rational design. They are constructed to the best standards to ensure good service and outstanding safety.

Please read this manual carefully, it will provide all the advice needed to allow you to obtain the best results from the very first day.

#### ATTENTION:

- Before using the appliance, do not forget to remove the protecting parts of the appliance.

• **WARNING** - Accessible parts will become hot when in use. To avoid burns and scalds children should be kept away.

#### - WARNING -

In order to prevent accidental tipping of the appliance, for example by a child climbing onto the open oven door, the stabilizing means must be installed.

#### - WARNING

This appliance is not intended for use by persons (including children) with reduced physical, sensory or mental capabilities, or lack of experience and knowledge, unless they have been given supervision or instruction concerning use of the appliance by a person responsible for their safety.

Children should be supervised to ensure that they do not play with the appliance.

Young children and infirm persons should not be left unsupervised in the vicinity.

#### - WARNING

Before you use the appliance for the first time, check that the plastic films protecting some parts (fascia panel, parts in stainless steel, etc.) have been removed.

#### - WARNING:

A steam cleaner is not to be used cleaning this appliances.

#### - WARNING

**DO NOT** place inflammable materials or plastic utensils in the warming drawer.

**DO NOT SPRAY AEROSOLS IN THE VICINITY OF THIS APPLIANCE WHILE IT IS IN OPERATION.**

Not for use in marine craft, caravans or mobile homes unless each burner is fitted with a flame safeguard.

WHERE THIS APPLIANCE IS INSTALLED IN MARINE CRAFT OR IN CARAVANS, IT SHALL NOT BE USED AS A SPACE HEATER

**DO NOT MODIFY THIS APPLIANCE.**

## POSITIONING

Important: Fix the chain located next to the gas connection on both sides of the cooker to the wall to prevent the cooker from tilting. Both chains must be securely fixed.

Make sure that the wall surface behind the Cooker is non-combustible (will not catch fire).

Where a painted surface is adjacent, a fire retardent paint surface is recommended. Wallpaper, wood, or fabric should not be used behind or next to the cooker.

### Clearances to combustible materials

"Any adjoining wall surface (side or rear) situated within 200mm of any hob burner must be a suitable non-combustible material from the edge for a height of 150mm for the entire length of the cooker.

Any combustible construction above the cooker must be at least 650mm above the maintop." Ensure that a power and gas supply are nearby. The Cooker should be located carefully so that the heat produced by it has plenty of space to escape. The diagram below shows an ideal configuration.

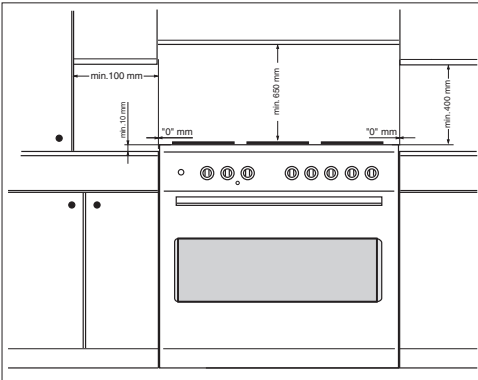

No part of any adjoining wall surface can be made of combustible materials. The protection of combustible materials required by Clause 5.12.1.1 of AS/NZS 5601 is the fixing of 5 mm thick ceramic tiles to the surface or attaching fire resistant material to the surface and covering with sheet metal with a minimum thickness of 0.4 mm.

### Clearances to non-combustible materials

"If the cooker is being fitted next to cupboards or adjoining wall surfaces, which are within 200mm from the edge of the hob burner and of a suitable non-combustible material as specified in AS/NZS 5601, then ensure that a distance of at least 6cm is left between the edge of the cooker and the non-combustible material. This gap is to allow plenty of space for the heat produced by the cooker to escape on each side of the cooker.

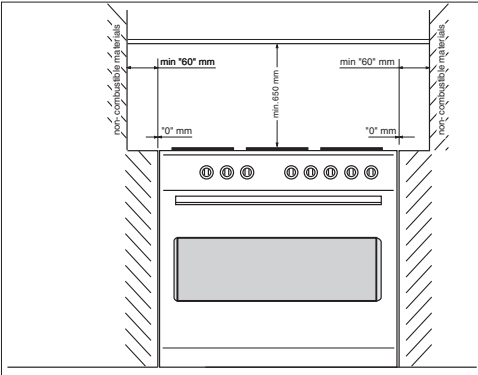

### Note:

The cooker is fitted with 4 legs for an eventual alignment in height with the furniture (fig. 1 A or 1 B according to the models).

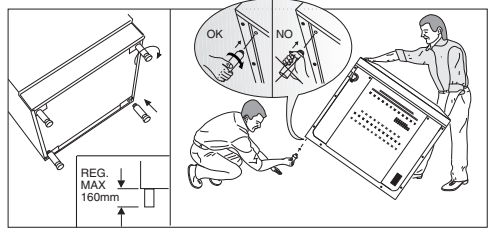

Fig. 1 A

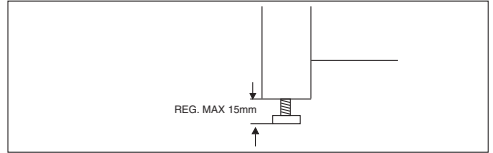

Fig. 1 B

If the cooker is placed on a base, measures have to be taken to prevent it from slipping off the base.

### TO FIX THE COOKER TO THE REAR WALL

**WARNING** - For safety reasons and to prevent tipping of the appliance, these stabilizing means must be installed.

The cooker is equipped with 2 chains fixed on each side at the rear of the cooker near the top (see Fig. A). The chains are fitted with "spring clips" which must be clipped to the "screw eyes" provided with the cooker. Install the "screw eyes" as follows:

1. Drill four 6mm holes (position 1 - 2 - 3 - 4) in the wall as in Fig. A.
2. Insert part "R" into the holes then screw in the "screw eyes" part "G" see Fig. B.

Note: If the part provided is not suitable for the wall material please use an appropriate device to ensure secure holding of the "screw eyes" to the wall.

3. Bring the cooker near the wall and clip the chains on the "screw eyes" as in Fig. C.

**IMPORTANT:** If the cooker is moved for any reason (e.g. maintenance) resulting in the cooker being unclipped from the wall, the cooker must be re-clipped to the wall at the completion of the task.

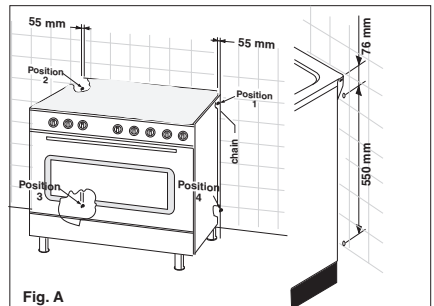

Fig. A

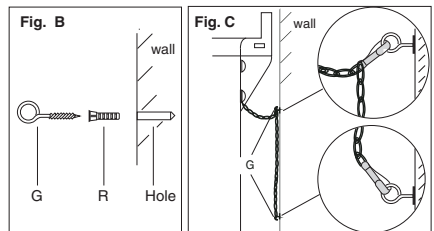

Fig. B

Fig. C

## GAS CONNECTION

Should conform to gas utility regulations e.g. AS/NZS 5601 Gas installations; also refer to rangehood manufacturers recommendations.

Check gas pressure, note the correct setting from the data plate sealed inside the front appliance drawer \* .

This appliance can be connected with rigid pipe as specified in AS/NZS 5601 table 3.1 or with an AGA approved, Class B or D flexible hose with 10mm I.D. and 1.2m max. length in accordance with AS/NZS 5601 for a 'high level connection'. The hose should not be subjected to abrasion, kinking or permanent deformation and should be able to be inspected along its entire length. Unions compatible with the hose fittings must be used and connections tested for gas leaks. The fixed consumer piping outlet should be at approximately the same height as the cooker connection point, pointing downwards and approximately 150mm to the side of the cooker.

The hose should be clear of the floor when the cooker is in the installed position.

Ensure that the chain prevents stress on the hose assembly when the cooker is moved out of its normal operating position.

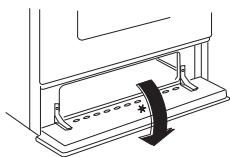

This appliance from the factory suitable for NATURAL gas but, if necessary, can be adjusted for U-LPG by authorised person.

For the adjustments to U-LPG please operate as specified in the paragraph GAS CONVERSION AND ADJUSTMENT (pag 4).

The Gas Connection is male 1/2" BSP and is situated at the right hand rear of the appliance, approximately 40mm from the side and 695mm from the floor (depends on adjustment of feet).

The appliance shall be installed by an authorized person in accordance with the manufacturer's installation instructions, relevant local fitting regulations, municipal building regulations, the AS/NZS 5601 code for gas burning appliances and equipment and other relevant statutory code band regulations. If you have some doubts, please contact the authorities for confirmation concerning the characteristics of the gas and electricity output.

The appliance is generally preset for natural gas (so no other adjustment is necessary) ensure regulator is fitted for N.G.

Ensure that all foreign matter has been cleared from the gas supply line and also purge all air from the gas system. Connect to regulator, tighten and check the installation to ensure no gas leaks occur.

### IT IS RECOMMENDED THAT A SERVICETAP AND UNION BE FITTED ADJACENT TO THE APPLIANCE INLET TO FACILITATE FUTURE SERVICING.

5 burner models: set the burner pressure to 1kPa for Natural Gas and 2.75kPa for U-LPG with the wok burner operating a full rate'. For commissioning of the appliance with the Oara 97 regulator for Natural Gas, the test point pressure should be 1.00kPa with all burners operating on HIGH.

Apply a manometer to the test nipple and reset the regulator if necessary. Do not forget to replace the test nipple screw and to leave the instructions book with the user.

### VERY IMPORTANT FOR THE INSTALLER

Do not attempt to turn or stress threaded elbow of the manifold: you risk damage to this part of the gas appliance which may void the manufacturers warranty.

**Before Leaving** - Check all connections for gas leaks with soap and water. DO NOT use a naked flame for detecting leaks. Ignite all burners to ensure correct operation of gas valves, burners and ignition. Turn gas taps to low flame position and observe stability of the flame.

When satisfied with the cooker, please instruct the user on the correct method of operation.

In case the appliance fails to operate correctly after all checks have been carried out, refer to the authorised service provider in your area.'

## GAS CONVERSION AND ADJUSTMENT

When used with natural gas all burners have been preset at our factory and further adjustment should not be necessary. Conversion kits to other gases are available from the place of purchase. Do not attempt to fit the conversion kit yourself. Conversion to U-LPG gas should only be carried out by an authorized technician.

## GAS ADJUSTMENTS

- change the injectors
- adjust the minimum flow

\*When converting from Natural Gas to U-LPG ensure that the NG regulator is removed and replaced with the Test Point Assembly. A gas regulator suitable for a supply pressure of 2.75kPa should be part of the gas tank supply and should be adjusted with the wok burner operating at maximum.

## REPLACEMENT OF THE INJECTORS

When required to operate on other gas replace the injectors in accordance with information referred to in chart below.

TAB. 1

Natural Gas	1.00 kPa	Jet mm Ø	Burners	Power MJ/h
with GC & GE & GP & GL & YP & GU pan supports		0.90	Auxiliary	4.0
		1.20	Semi-rapid	7.1
with GC & GE & GP & GL & GU pan supports		1.50	Rapid	11.0
		1.35	Rapid	9.1
-				
-				
-				
with GC & GE & GP & GL & YP & GU pan supports		1.63	TC1	12.7
U - LPG	2.75 kPa	Jet mm Ø	Burners	Power MJ/h
with GC & GE & GP & GL & YP & GU pan supports		0.53	Auxiliary	3.7
		0.73	Semi-rapid	7.0
with GC & GE & GP & GL & GU pan supports		0.95	Rapid	11.7
		0.87	Rapid	10.2
-				
-				
-				
with GC & GE & GP & GL & YP & GU pan supports		1.00	TC 1	12.7
Regulator		NG Regulator	LP Test point adaptor	

NOTE: GE = Enameled Steel pan supports  
 GL = Light Cast Iron pan supports  
 YP = Light Cast Iron pan supports (evolution)  
 GP = Heavy Cast Iron pan supports  
 GC = Flat heavy cast iron pan supports  
 GU = Flat heavy cast iron pan supports

## SPECIAL NOTE

After installation or any servicing operation, always ensure that the appliance is gas sound and that the components are now operating correctly. Items removed during servicing should be replaced in the reverse order to their removal.

In order to change the work-top injectors, it is necessary to act as follows:

- remove the grids
- remove burners and flame-spreaders.

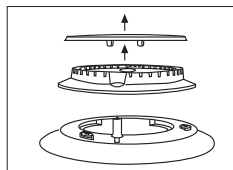

- change the injector (see Fig. C) and replace it with another one suitable for the new type of gas (see tab. 1)

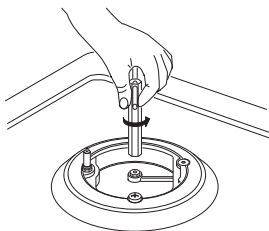

Fig. C

**MINIMUM FLOW ADJUSTMENT FOR HOB-TOPTAPS**

In order to adjust the minimum flame setting proceed as follows: switch the burner on, and set the knob at the minimum position ▲. Remove the knob from the tap, place a small bladed screwdriver down the centre of the tap shaft (fig. 2A).

**Attention:** on taps with a security valve, the minimum adjusting screw «Z» is on the body of the gas tap (fig. 2B).

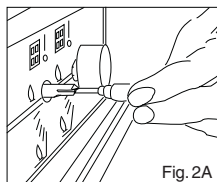

Fig. 2A

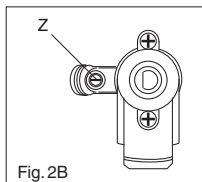

Fig. 2B

Unscrew the adjusting screw in order to increase the flow or screw it to decrease the flow.

The correct adjustment is obtained when the flame has a length of about 3 or 4 mm.

For butane/propane gas, the adjusting screw must be screwed in tight.

Make sure that the flame does not go out turning quickly from the max. flow ▲ to the minimum flow ▲.

Refit the knob again.

**ELECTRICAL CONNECTION**

The appliance must be installed by a suitably qualified person in accordance with these instructions and with the requirements of the Australian Wiring Rules AS/NZS 3000.

Fixed wired installations are to be provided with suitable isolation means in accordance with the said rules.

Any plug socket installed for the purpose of connecting the appliance to supply must be readily accessible when the appliance is installed. Before making the connection, make sure that:

- 1) the safety circuit-breaker and the electrical system are able to withstand the load of the appliance (see nameplate).
- 2) the power supply system has an earth connection in good working order in accordance with the regulations in force;

**IMPORTANT**

The wires in the mains lead are coloured in accordance with the following code:

GREEN & YELLOW .....EARTH  
 BLUE.....NEUTRAL  
 BROWN .....LIVE

Electric power...1,5 mm<sup>2</sup> 3 core cable (15 amp. Fuse required). Should conform to local authority requirements.

Also refer to rangehood manufacturers recommendations.

This appliance is supplied with a plug & cord, simply plug into a 3 pin household socket outlet witch is properly earthed.

**WARNING: THIS APPLIANCE MUST BE EARTHED.**

The flexible mains lead and plug must not be in contact with hot surfaces.

**WARNING:**  
 Children should be kept away while the oven or grill is in use since accessible parts become hot.



- Do not use oven base panel as a shelf, make use of the oven shelves.
- To avoid splattering and smoke, position collecting tray under the grill with some water in it.
- Always turn pan handles to the side or to the back of the hob. If they are left out into the room they can easily be hit or reached by children, this knocking the pan off the hob.
- Don't let children sit down or play with the oven door. Do not use the drop down door as a stool to reach above cabinets.
- Once your cooking is over make sure to close the main gas supply.

**WARNING**

\* This appliance is not intended for use by young children or infirm persons without supervision.

\* Young children should be supervised to ensure that they do not play with the appliance.

\* If the supply cord is damaged, it must be replaced by the manufacturer, its service agent or similarly qualified persons in order to avoid a hazard.

**- WARNING -**

In order to prevent accidental tipping of the appliance, for example by a child climbing onto the open oven door, the stabilizing means must be installed.

**- 1 Minute Tour -**

**Be safe**

Please read the rest of the instruction book which contains important information to help you use the appliance safely and efficiently.

**Gas and Electricity on**

Make sure that the gas supply is turned on and that the appliance is plugged in and switched on. The ignitor needs electricity.

In case there is no electric current, the burner can also be lighted using a match.

It is recommended that pans suitable to the size of the burner should be used as follows:

BURNERS	PANS	
	fl min.	fl max
AUXILIARY	80 mm	160 mm
SEMI-RAPID	120 mm	200 mm
RAPIDE	200 mm	230 mm
TRIPLE CROWN	230 mm	260 mm

Always use pans with a flat base diameter, which are well balanced and stable in use, a pan which overhangs the hotplate should not be used. Avoid using old, misshapen pans, or pans which are unstable when placed on a flat surface. Do not use "split pans" as they are inherently unstable.

To save gas, always position pans centrally over the burners and adjust the flames so that they do not lick up the sides of the pan and only the base is heated. Always put lids on saucepans and boil only the amount of liquid you use. When the liquid has boiled adjust the setting to maintain a simmer. Do not light the burner until the pan is in position and turn off the burner before removing the pan. In hard water areas, descale kettles regularly. For safety, keep saucepan handles turned to a safe position so they are out of reach of small children and cannot be accidentally knocked.

To turn the burner OFF, turn the control knob clockwise to the OFF setting (marked with a dot ●)

The small flame indicates the 'low position'. Turn the knob to it after the contents of a pan have boiled.

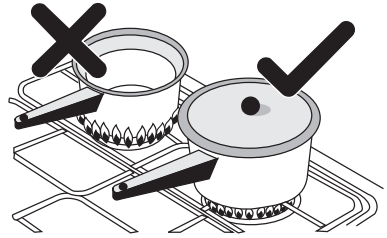

The smaller burners are for smaller pans and simmering. Make sure flames are under the pans. Using a lid will help the contents boil more quickly.

### Automatic electric ignition

- The drawing above each knob indicates which burner that knob controls. Push in and turn a knob anticlockwise to the large flame symbol.

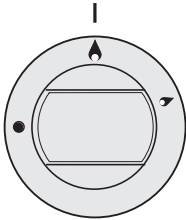

### WARNING

It is not recommended to press push button for ignition if all the burners are not located in the proper positions. The burner heads, burner skirts and pan supports are removable for better cleaning: Always ensure that the burner skirts and heads are replaced correctly so that the burners function safely and correctly. During the use of the appliance pay attention that water or any liquid does not enter into the appliance through the holes of the burners or around the rods of the valves or the push button electronic lighter.

Water or juice will produce dangerous short-circuits and can seriously damage the working of the Hotplate.

- At the same time press the IGNITION (spark) button.



### Automatic electric ignition

To turn on a burner, press the knob corresponding to the selected burner and turn it anticlockwise to the maximum position. Keeping the knob pressed, the electric automatic ignition of the burner will be started up. In case there is not electric current, the burner can also be lighted using a match.

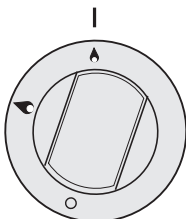

## HOW TO USE YOUR ELECTRIC OVEN

- Before cooking in the first time we recommend that the oven should be operated at 200° C for 30 minutes to remove any manufacturing greases and odours.
- Do not place items or pan directly on to the oven botton.
- Foil should only be used to cover food and not oven shelves or party of the oven. When used improperly will obstruct the air circulation causing problems in cooking and/or harmful accidents.

### MULTIFUNCTIONAL OVEN

#### The oven is fitted with:

- a lower heating element;
- an upper heating element;
- a circular heating element surrounding the fan.

**N.B.:** Always set the temperature on the thermostat knob before selecting any of the functions.

#### Oven thermostat knob

To obtain an oven temperature between 60°C and MAX°C, turn the knob clockwise.

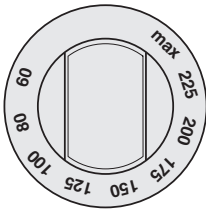

#### Oven commutator knob

Depending on the type of oven, it is possible to select one of the following functions turning the commutator knob clockwise.

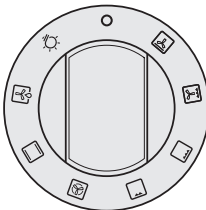



#### Note:



All the functions mentioned above switch the oven internal light on. A warning light on the control panel will stay lit until the temperature is reached; after it will light up intermittently.

**Always use the oven with the oven door closed.**

#### Use of the oven

Note: ovens with separate thermostat and commutator. When the functions   are used, place the thermostat knob between 180 + 200°C as maximum temperature.

#### ATTENTION:

The temperature shown on the control panel corresponds to the temperature in the oven centre only when the functions selected are  or .



When you turn the control knob to this position, the light will be on for all the following operations.



#### Defrosting with fan

The air at ambient temperature is distributed inside the oven for defrosting food very quickly and without proteins adulterations.



#### Natural convection

Both the lower and upper heating elements operate together. This is the traditional cooking, very good for roasting joints, ideal for biscuits, baked apples and crisping food. You obtain very good results when cooking on a shelf adjusting the temperature between 60 and MAX°C.



#### Fan oven

Both the fan and the circular heating element operate together. The hot air adjustable between 60 and MAX°C is evenly distributed inside the oven. This is ideal for cooking several types of food (meat, fish) at the same time without affecting taste and smell. It is indicated for delicate pastries.



#### Medium grill

It is indicated for grilling and gratinating small quantities of traditional food.

The thermostat knob must be placed on the maximum position.



#### Total grill

It is indicated for grilling and gratinating traditional food. Turn the thermostat control knob to the 200°C position.



#### Fan assisted total grill

The air which is heated by the grill heating element is circulated by the fan which distributes the heat on the food.

The fan assisted grill replaces perfectly the turnspit. You can obtain very good results also with large quantities of poultry, sausage, red meat. Turn the thermostat control knob to the 200°C position.



#### Air forced lower heating element

The air which is heated by the lower heating element is circulated by the fan which distributes the heat on the food.

This function can be used to sterilize food. This function can be used between 60 and MAX°C

## GENERAL INSTRUCTION

**Warning:** remember ovens get hot; some parts naturally become very hot, notably the glass oven door and the protective strip. Keep children away from oven at all times and warn them about the danger.

#### GUIDE FOR CONVENTIONAL COOKING

(Outer ring of upper electric element and lower electric element ON) The following Cooking Guides give the recommended shelf positions (counted from the bottom), thermostat settings and approximate cooking times for a range of baked items, using the



conventional oven, using one tray only. Cooking results are a matter of personal preference and may easily be adjusted to suit individual requirements by slight adjustment of the temperature and or cooking time. Preheating of the oven is recommended for 10-15 minutes or until the oven thermostat indicator light switches off to show the selected temperature has been reached.

When using a baking tray it should be placed centrally on the oven shelf with the short sides of the tray parallel to the sides of the oven. Do not use trays, tins or dishes larger than 380 mm (15") long, 356 mm (14") wide, as cooking results may be impaired.

smoking and may start a fire.

Remember do not place pan or items directly onto the oven base. Never leave unit unattended at high heat settings. Boil over causes smoking/and greasy spill over that may start a fire.

If a grease fire should occur in a pan put out the flame by placing a lid on the pan. Do not throw water on a grease fire.

## GUIDE FOR FORCED CONVECTION COOKING

### (Back rolled electric element with fan)

The accessories provided with the oven can be slotted in at 5 positions: the following guide concerns cooking times and thermostat settings using N. 2 shelves on the same time (in position N. 2 and N. 4). Cooked results are a matter of personal preference and may easily be adjusted to suit individual requirements by slight adjustment of the temperature and/or cooking time, or when using more or less shelves in the same time. Preheating of the oven is recommended for 10-15 minutes or until the oven thermostat indicator light switches off to show the selected temperature has been reached.

When using a baking tray it should be placed centrally on the oven shelf with the short sides of the tray parallel to the sides of the oven. Do not use trays, tins or dishes larger than 380mm (15") long, 356 mm (14") wide, as cooking results may be impaired.

Food	Thermostat setting °C	Shelf Position (Counted from Bottom)	Cooking Time
Small cakes (12 on tray)	195	3	20 - 30 mins.
Victoria sandwich (2x7"/180mm)	190	3	25 - 35 mins.
Swiss roll or whisked sponge	200	3	20 - 25 mins.
Fruit cake (8"/205mm)	155	2	2 - 3 hours.
Scones	260	3	10 - 20 mins.
Meringues	95	2	2 - 3 hours.
Shortcrust Pastry	210	3	25 - 45 mins. depending
Puff or Flaky Pastry	220	2	20 - 35 mins. upon
Choux Pastry	220	3	25 - 35 mins. dish
Biscuits	200/220	3	15 - 25 mins. depending upon type
Bread	250	2	30 - 40 mins.
Milk pudding	165	2	1 H - 2 hours.
Pizza	270	3	25 mins.
Lasagne	170	3	75 mins.
Oven noodles	160	3	75 mins.
BEEF on bone & crusty (rare) (medium) (well done)	270 rare	3	12 mins. per 1lb (500 g) plus 12 mins.
	220 °C	3	15 mins. per 1lb (500 g) plus 15 mins.
	220 °C	3	20 mins. per 1lb (500 g) plus 20 mins.
	180 °C	3	25 mins. per 1lb (500 g) plus 15 mins.
LAMB on bone	220 °C	3	20 mins. per 1lb (500 g) plus 20 mins.
Boned and rolled	170 °C	3	27 mins. per 1lb (500 g) plus 27 mins.
	220 °C	3	25 mins. per 1lb (500 g) plus 25 mins.
Boned and rolled	170 °C	3	35 mins. per 1lb (500 g) plus 20 mins.
	220 °C	3	25 mins. per 1lb (500 g) plus 25 mins.
PORK on bone	220 °C	3	25 mins. per 1lb (500 g) plus 25 mins.
Boned and roller	180 °C	3	30-35 mins. per 1lb (500 g) plus 35 mins.
VEAL on bone	220 °C	3	25 mins. per 1lb (500 g) plus 25 mins.
Boned and roller	220 °C	3	30 mins. per 1lb (500 g) plus 30 mins.
CHICKEN	220 °C	3	20 mins. per 1lb (500 g) plus 20 mins.
	170 °C	3	25 mins. per 1lb (500 g) plus 25 mins.
TURKEY	220 °C	3	20 mins. per 1lb (500 g)
	170 °C	3	25 mins. per 1lb (500 g)
	220 °C	3	20 mins. per 1lb (500 g)
DUCK	220 °C	3	20 mins. per 1lb (500 g)
	170 °C	3	25 mins. per 1lb (500 g)
GOOSE	220 °C	3	20 mins. per 1lb (500 g) plus 20

## PLATE WARMING

Ovenproof plates and dishes may be warmed in the oven on a low temperature setting. Remember do not place items directly into the oven base.

**Warning:** do not use foil to cover the oven shelves, or any part of the oven interior including the oven base. Foil should only be used to cover food and cooking dishes. Always place items which may boil over (e.g. fruit pies) on a baking tray to prevent spillage burning onto the oven base. Foil used improperly is frequent cause of oven problems and painful accidents. Avoid letting grease deposit collect around the upper heating element: it will cause

Food	Thermostat setting °C	Cooking Time
Small cakes (12 on tray)	175	15-25 mins.
Victoria sandwich (2x7"/180mm)	170	20-30 mins.
Swiss roll or whisked sponge	180	15-20 mins.
Fruit cake (8"/205mm)	135	1 H - 2 H hours.
Scones	210	8-15 mins.
Meringues	80	1 H - 2 H hours.
Shortcrust Pastry	190	20-40 mins. depending
Puff or Flaky Pastry	200	15-30 mins. upon
Choux Pastry	200	20-30 mins. dish
Biscuits	170/180	10-20 mins. depending upon type
Bread	200/220	25-35 mins.
Milk pudding	150	1 H - 2 hours.
Pizza	250	20 mins.
Lasagne	165	60 mins.
Oven noodles	150	60 mins.
BEEF on bone	230 rare & crusty	9 mins. per 1lb (500 g) plus 9 mins.
BEEF on bone	190 °C (rare)	15 mins. per 1lb (500 g) plus 8 mins.
	190 °C (medium)	20 mins. per 1lb (500 g) plus 10 mins.
	160 °C (well done)	25 mins. per 1lb (500 g) plus 8 mins.
Boned and rolled	190 °C (rare)	20 mins. per 1lb (500 g) plus 10 mins.
	190 °C (medium)	25 mins. per 1lb (500 g) plus 15 mins.
	160 °C (well done)	30 mins. per 1lb (500 g) plus 8 mins.
	190 °C	20 mins. per 1lb (500 g) plus 10 mins.
LAMB on bone	155 °C	27 mins. per 1lb (500 g) plus 14 mins.
	190 °C	25 mins. per 1lb (500 g) plus 14 mins.
Boned and rolled	190 °C	25 mins. per 1lb (500 g) plus 14 mins.
	155 °C	25 mins. per 1lb (500 g) plus 14 mins.
PORK on bone	200 °C	25 mins. per 1lb (500 g) plus 14 mins.
Boned and roller	160 °C	30-35 mins. per 1lb (500 g) plus 18 mins.
VEAL on bone	200 °C	25 mins. per 1lb (500 g) plus 14 mins.
Boned and roller	200 °C	30 mins. per 1lb (500 g) plus 14 mins.
CHICKEN	200 °C	20 mins. per 1lb (500 g) plus 10 mins.
	155 °C	25 mins. per 1lb (500 g) plus 13 mins.
TURKEY	200 °C	18 mins. per 1lb (500 g) plus 14 mins.
	155 °C	23 mins. per 1lb (500 g)
DUCK	200 °C	18 mins. per 1lb (500 g)
	155 °C	23 mins. per 1lb (500 g)
GOOSE	180 °C	18 mins. per 1lb (500 g) plus 20 mins.

## USING THE GRILL





The grill is situated in the top of the oven compartment.  
The grill pan should be located on the top oven shelf position.

### Warning:

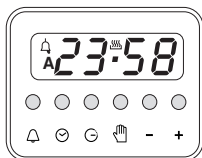
Do not place fatty foods too close to the grill and never leave the grill unattended. If fatty foods are grilled, or roasting has been cooked in the oven at a high temperature the grill element may smoke. This is not dangerous and the smoke is caused by the fat burning off when the grill element is hot. Leave the grill element on until the smoking has stopped then use as normal. If a grease fire should occur in a pan put out the flame by placing a lid on the pan. Do not throw water on a grease fire.

## INSTRUCTIONS FOR USE OF CONTROL DEVICES (ACCORDING TO THE MODELS)



	Minute timer
	Cooking time
	Cooking end
	Manual
-	Subtract time
+	Add time

### Programmer with electronic clock - LED display

#### Functions

Cooking time, cooking end time, manual position, clock, minutes counter, times to be set up to 23 hours 59 minutes.

#### Display

Fluorescent display with 4 figures of 7 segments to indicate time and cooking times.

Cooking time and manual function = pan symbol  
Automatic function = AUTO  
Minutes counter = bell symbol

The symbols light up when the corresponding functions are selected.

#### Setting

To set, press and release the desired function, and within 5 seconds set the time with + and - buttons.

#### + and - buttons.

The + and - buttons increase or decrease the time at a speed depending on how long the button is pressed.

#### Setting the time

Press any two buttons manual at the same time, and + or - button to set the desired time. This deletes any previously set programme. The contacts are switched off and the AUTO symbol flashes.

#### Manual use

By pressing the manual button the relay contacts switch on, the AUTO symbol switches off and the saucepan symbol lights up. Manual operation can only be enabled after the automatic programme is over or it has been cancelled.

#### Automatic use

Press the cooking time or end time button to switch automatically from the manual to the automatic function.

#### Semi-automatic use with cooking time setting

Press the cooking time button and set the desired time with + or -. The AUTO and cooking time symbols light up continuously. The relay switches on immediately. When the cooking end time corresponds to the time of day, the relay and cooking time symbol switch off, the sound signal rings and the AUTO symbol flashes.

#### Semi-automatic use with end time setting

Press the end time button. The time of day appears on the display. Set the cooking end time with + button. The AUTO and cooking time symbols light up continuously. The relay contacts switch on. When the cooking end time corresponds to the time of day, the relay and the cooking time symbol switch off. When the cooking time is up, the AUTO symbol flashes, the sound signal rings and both the relay and the cooking time button switch off.

#### Automatic use with cooking time and end time setting

Press the cooking time button and select the length of the cooking time with + or - button. The AUTO and cooking time symbols light up continuously. The relay switches on. By pressing the cooking end time button the next cooking end time appears on the display. Set the cooking end time with + button. The relay and the cooking time symbol switch off.

The symbol lights up again when the time of day corresponds to the cooking start time. When the cooking time is up, the AUTO symbol flashes, the sound signal rings, the cooking time symbol and the relay switch off.

#### Minutes counter

Press the minutes counter button and set the cooking time with + or - button. The bell symbol lights up when the minutes counter is operating. When the set time is up, the sound signal rings and the bell symbol switches off.

#### Sound signal

The sound signal starts at the end of a programme or of the minutes counter function and it lasts for 15 minutes.

To stop it, push any one of the functions buttons.

#### Start programme and check

The programme starts 4 seconds after it has been set. The programme can be checked at any time by pressing the corresponding button.

#### Setting error

A setting error is made if the time of day on the clock falls within the cooking start and end times. To correct the setting error, change the cooking time or cooking end time. The relays switch off when a setting error is made.

#### Cancelling a setting

To cancel a setting, press the cooking time button and then press the - button until 00 00 appears on the display.

A set programme will automatically cancel on completion.

## MINUTES COUNTERS

Turn the knob clockwise to set the desired cooking time. The minutes minder can be adjusted from 1 to 60 minutes. A sound signal will inform you that the chosen time is up.

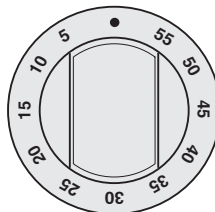

## PROGRAMMER WITH COOKING END TIME

For a manual operation of the programmer, turn the knob anticlockwise to . Adjust the cooking time by turning the knob clockwise. Select the cooking time with the relevant knob (max. 120 min.). The oven will switch off automatically when the cooking is up.

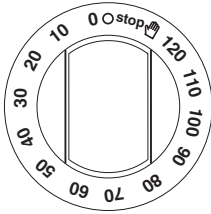

## PCI "Campanil" TR 259 Analogic

### Setting the clock

Press the control knob and turn clockwise.

### Alarm programme adjustment

Turn the knob clockwise without pressing it in. At the end of the programmed time an alarm will sound.

To cancel it, turn the knob to the bell.

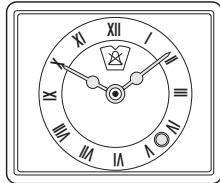

## Instructions and operation PCI TR 331.

To set the clock press the knob and turn anti-clockwise.

To adjust cooking time, turn the knob clockwise without pressing it in. The end of cooking time is announced by an alarm bell, which is cancelled by turning the knob to position .

For manual connection, turn the knob to position .

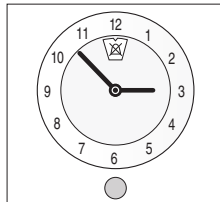

## ELECTRONIC TIMER FOR COOKER

### Functions

#### On

The display flashes.

#### Time setting

Press the left button.

Set the time with buttons "+" and "-".

This function remains activated 7 seconds after the last +/- operation.

#### Timer setting

This function is permanently activated and it will be immediately set with +/- buttons. During setting the units are 10 seconds.

During count down the timer takes priority on the display.

The units are seconds. The maximum time is 99 minutes.

The relay contact (when available) is closed during the count down only.

### Reset timer

Press "+" and "-" buttons together and release "+" button first.

### Signal

The signal after time out will stay 7 minutes if it has not been reset with the "+" button (one touch only).

### Signal frequency

When the display shows the time of day, the signal frequency can be selected by pressing the "-" button.

Three different frequencies are selectable.

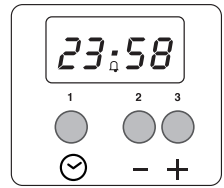

- 1 Time of the day
- 2 Timing and insertion
- 3 Signal timing and insertion

## MECHANICAL PROGRAMMER WITH COOKING START/END TIME

Setting the clock: press knob B and turn it anti-clockwise.

Adjustment of starting time: press knob A and turn it anti-clockwise.

Adjustment of connection time: turn knob B anti-clockwise without pressing it in.

The end of the connection is announced by an alarm bell, which can be stopped by turning knob B to position 0 without pressing it in. Manual connection: turn knob B to position I a  without pressing it in.

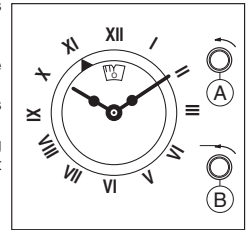

## USE OF THE ELECTRIC GRILL

### USING THE GRILL

Turn the oven knob to the right and place it on the grill position .

The grill pan should be located on the top oven shelf position and is provided with two detachable grill pan handles which are engaged over the front edge of the pan between the indentations provided. A wire grid is supplied. The grill pan handle should be removed from the grill pan during the grilling operation and only fitted for removal or insertion of the grill pan particularly when hot. Always preheat the grill on full for 3-5 minutes before inserting the food.

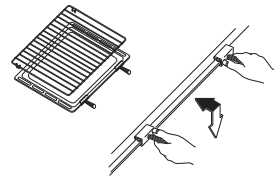

The user can change the shelves, depending on his personal wishes and on the different food.

Geat the oven 5 minutes before introducing the food.

**To remove the shelves from the oven,** pull them forward you, tilt front end upward and pull them out.

**To replace,** ct in the opposite manner as before.

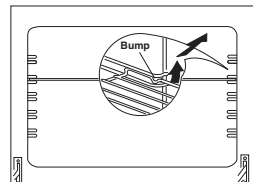

Install shelves by locating them in the horizontal guide rails on the oven walls. The raised portion of the shelf is to be facing the rear wall of the oven.

## TURNSPIT multiple (optional)

For utilization of the turnspit follow the instructions described.

- Thread the chicken or the cubes of meat for roasting on the spit **L**, ensuring that it is gripped safely between the two forks **F** and balancing it properly to avoid unnecessary strain on the transmission **R** (fig 8).
  - Put the spit on the support **G**, after having introduced its opposite end in the socket **P** of the transmission **R** (fig 8)
  - Put the support **G** completely into the oven so that the bar **I** goes into the socket **H** of the turnspit motor **M** (fig 8A).
  - Place the drip-tray with some water under the turnspit, on the lowest level
  - when removing the spit, wear oven mitts, pull out support **G** and use the handgrip **A** operating in the contrary way (fig 8B).
- The turnspit can be operated turning thr knob clockwise on position .

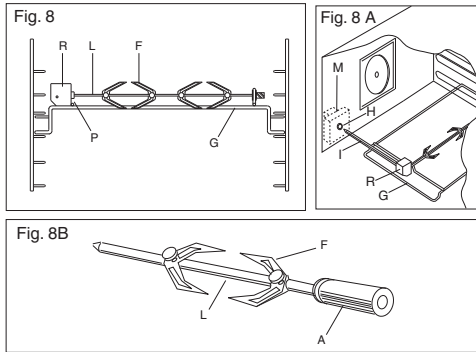

## TURNSPIT single (optional)

For utilization of the turnspit follow the instructions described.

- Put the food in spit **L** (see fig. 8C), paying attention to block it within the two forks **F** and to balance it, in order to avoid any unnecessary effort in motor **R**.
- Put the spit on support **G**, after having put its opposite end into hole **P** of motor **R**.
- Place the drip-tray with a little water under the spit.
- Start up motor **R** and turn the grill on.
- To remove the spit, operate in the opposite direction using knob **S** and protecting glove in isolating wool (fig.8C).

The turnspit can be operated turning thr knob clockwise on position .

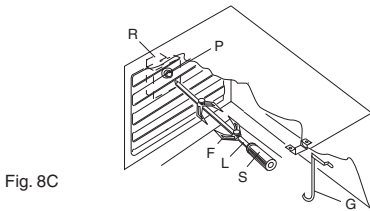

Fig. 8C

## CLEANING

Before cleaning the appliance, close the gas stopcock and unplug appliance or disconnect power at the main circuit breaker of the electrical system.

Do not clean the appliance surfaces when still hot.

Always clean off spillage as quickly as possible to prevent burning on which will make removal more difficult. Wash with a clean cloth soaked in hot soapy water, rinse and dry with a soft cloth.

**DO NOT USE ABRASIVES. CAUSTIC PASTES OR SPRAYS. COARSE CLEANING PADS OR POWDERS. DO NOT USE EXCESSIVE WATER WHEN CLEANING YOUR OVEN IN ORDER TO AVOID WATER PRESSING THROUGH CLEFTS INTO THE BACK OF CONTROLS PANEL OR OF THE UNIT.**

**NOTE:** A steam cleaner is not to be used for cleaning this appliance .

### Pan supports and burners

The burner heads can be removed for cleaning.

**NB** Do not drop hot burner caps in cold water.

Because of the rapid cooling they might get damaged.

Lift off and soak for about 10 minutes in hot water with a little detergent. After having cleaned and washed them, dry them carefully.

Make sure that no burner holes are clogged.

Clean the burners once a week or more frequently if necessary.

Make sure you have reassembled the burners correctly.

Pan supports can be washed by hand or in a dishwasher.

Remember to remove rubber feet (if fitted) prior to washing.

Refit them afterwards.

Do not use harsh abrasive cleaners or sharp metal scrapers to clean the oven door glass since they can scratch the surface, which may result in shattering of the glass.

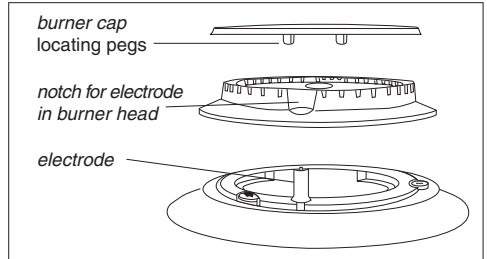

For a triple crown burner, make sure head "C" and covers "A" and "B" are properly placed on their seats as figure **N** and not off-centered as in figure **P**.

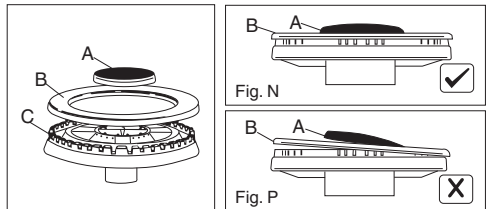



### Daily

Regular wiping down directly after use prevents dirt from burning on. Clean the appliance with water and a detergent or all purpose cleaner.

Avoid using too much water to prevent it entering the burner or ventilation openings.

**Interior:** the oven shelf carriers and the back fan cover can be removed for easier cleaning. To do this, remove all the shelves and spring off the side carriers by applying pressure downwards to unhook the top. The back can now be removed by unscrewing the screw at each side. Replace in a similar manner. (Fig. Q-R)

**Oven accessories** (shelves, trays etc) should be washed in mild detergent solution and should not be treated with abrasives. The oven interior panels should be cleaned with mild detergent solution, mild cream cleaners or a moist soap pad.

**Install shelves by locating them in the horizontal guide rails on the oven walls.**

**The raised portion of the shelf is to be facing the rear wall of the oven.**

### IMPORTANT

Do not use excessive water when cleaning the oven and avoid water passing through the fan grill or ducts in the oven back .

Avoid letting grease deposit collect around the upper heating element: it will cause smoking and may start a fire.



Fig. Q

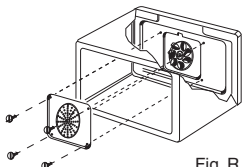

Fig. R

### WARNINGS

**Before performing any repair or operation, switch the appliance off and close the gas tap.**

The manufacturer declines all responsibility for any damage to persons, animals or things caused by failure to observe the rules indicated above. In case it is necessary to repair or replace the inside components, act as follows:

### WARNINGS

Isolate the cooker from the electricity supply before attempting to replace the oven lamp.

**The oven lamp** used is of a special type withstanding high temperatures. To replace it, act as follows: disassemble the protecting glass (A) and replace the burnt lamp with one of the same type. Reassemble the protecting glass.

### DISASSEMBLE OF WORK-TOP

In case it is necessary to repair or replace the inside components, act as follows:

Remove the grids, remove burners and flame-spreaders (see fig. 13), unscrew the visible screws "V" placed on the work-top (see fig. 14). Disassemble the work-top by unscrewing the rear screws "A" (see fig. 15A or 15 B according to the models). In this way it is possible to lift the work-top and to reach the inside components.

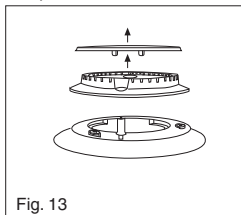

Fig. 13

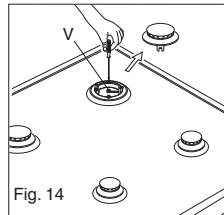

Fig. 14

### OVEN DOOR REMOVAL AND REFITTING

Open the door fully and turn the two hinge disks clockwise (fig.S). Reclose to about 45° and pull gently (fig. T).

To reassemble, keep the door at 45° and insert the arms of the hinge in the slots on the front of the oven, then turn the two hinge disks anticlockwise.

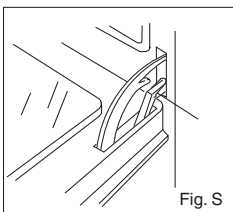

Fig. S

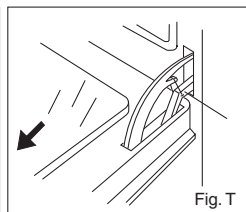
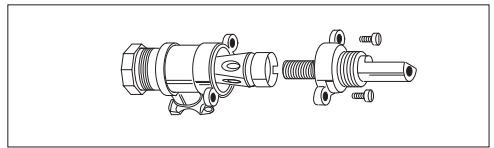
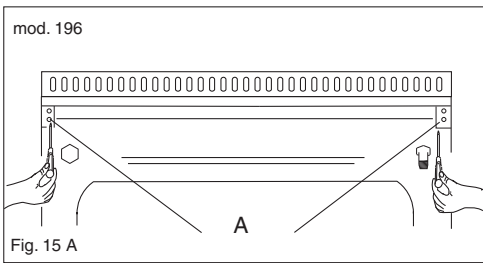

Fig. T



### TAPS REPLACEMENT

Act as follows: open the work-top and disassemble also the control panel as described on the previous paragraph. Unscrew screw nut D of the gas tube supplying the burner. Unscrew screw V fixing the tap to the bridge and remove it (see picture).

Note: Every time the tap is replaced, it is necessary to replace the seal gasket too check the connection seal by means of soapy water.

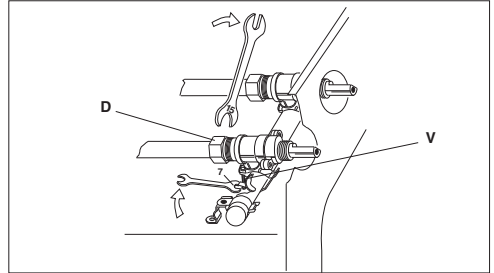
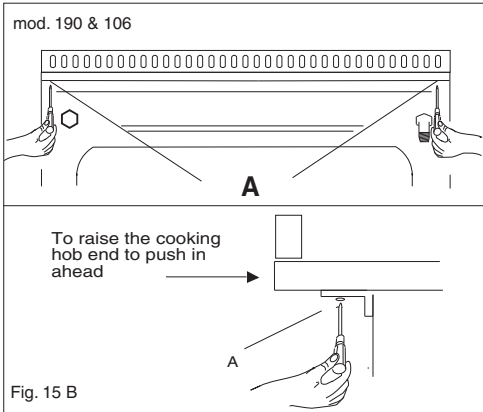

Clean the cone and its slot by means of a cloth soaked with diluent. Slightly grease the cone with the relevant grease, put it in its slot, and turn it some times. Remove the cone again, remove the exceeding grease making sure the gas entries are not obstructed by grease residuals. Assemble everything carefully in the opposite direction check the connection seal by means of soapy water.

### OVEN LIGHTS

Always ensure the oven unit is switched off at the mains before replacing the oven light bulb. To remove the light bulb, unscrew the glass cover anticlockwise and remove. Turn the bulb anticlockwise and remove. Replace with the same type of bulb (Type E14 threaded clear lamp 230/240 V. 25 watt T 300°C). Replace the light carefully and turn it clockwise.

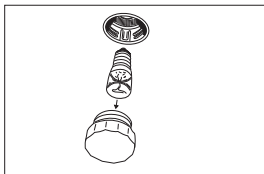

### GREASING OF TAPS

If a tap becomes hard to be turned, grease it using a specific grease withstanding high temperatures. Act as follows: open the work-top and disassemble also the control panel as described on the previous paragraph. Unscrew the two fixing screws from the burner body (see picture) and remove the cone.

Do not use the appliance as a space heater.

**If you smell gas**

**Open a window. Do not use any electrical switches. Immediately extinguish naked flames. Isolate appliance from gas mains supplies via the isolation stopcock. Contact local gas authority or emergency services as appropriate. In the event of food fire. Isolate appliance from electric / gas mains supplies if safe to do so. Try to extinguish flames with the appropriate equipment (fire blanket or extinguishing foam). Do not use water on cooking fat / oil fires.**

**If in difficulty call emergency services.**

- Do not store or use flammable products or aerosol containers near the hotplate or burners.
- Never flambe, under an extractor - even if the ventilator is switched off.  
The high flames can cause fire.

**For your safety and that of your children**

- Do not store items that are attractive to children above or near the appliance.
- Keep children well away from the appliance: do not forget that some parts of the appliance or of the pans become very hot and dangerous during use, and will take time to cool down.
- When cooking, do not use clothes that could catch fire and cause serious injury.
- Some "Wok" cooking pots are unstable. Check with the manufacturer before purchasing.
- Avoid using unstable and misshapen pans which may tilt easily and pans with a very small base diameter, e.g. milk pans, single egg poachers. The minimum pan diameter recommended is 125mm (5"). Smaller pans will be unstable.

Very large pans may cause walls or knobs to overheat. Using pans which are too big may deform the control knobs or discolour the walls. This is not covered by the guarantee.

- Carefully place all pans centrally over the burners.
- Always position pan handles safely away from the front of the hotplate and out of danger, particularly from small children.
- Never leave a chip pan unattended.
- Pans and kettles with down turned base rims should not be used.
- Simmering aids such as asbestos or mesh mats are NOT recommended. They will reduce burner performance and could damage the pan supports.
- Commercially available foil spillage aids are unnecessary on this hotplate.

Any of the following are considered to be abnormal operation and may require servicing:

- Yellow tipping of the hob burner flame.
- Sooting up of cooking utensils.
- Burners not igniting properly.
- Burners failing to remain alight.
- Burners extinguished by oven door.
- Gas valves, which are difficult to turn.

Your Installer should be contacted if you have any problems with the installation.

Before you call a service engineer please check if the problem is something you could fix yourself. The cause of the problem is often a simple one.

**THINGS TO TRY BEFORE CALLING FOR AN ENGINEER****Burner does not burn well**

Is the burner dirty or damp? Try cleaning and/or drying the burner. Appliance not suitable for your gas type? Check the identification plate on the hotplate base.

**Burner does not ignite**

Do the burners spark when you press the ignition button? If not is the power on? See 'Checking the power supply' section further on. If the power supply is OK then there is probably something wrong with the ignition system.

Are the electrode or burner slots blocked by debris?

Is the burner dirty or damp? Try cleaning and/or drying the burner. Is the burner trim correctly located?

Are the burner caps correctly located?

Check that there is not a problem with your gas supply. You can do this by making sure that other gas appliances you may have are working.

**Pan supports**

Aluminium pans may cause a metallic marking on the pan supports which does not affect the durability of the enamel and may be cleaned off with a metal cleaner such as 'Brasso'.

**Checking the power supply**

First check the socket by trying out another piece of electrical equipment in it.

If that works, renew the fuse in the hotplate plug. Use a 10 amp fuse. If the fuse 'blows' again there is a fault on the hotplate. Do not use a fuse with a higher rating. Do not carry out other electrical work. Unplug the hotplate and tell your installer.

**Power Failure**

In the event of a failure in the electrical supply the hotplate burners may be lit using a match.

**Ventilation**

The use of a gas cooking appliance results in the production of heat and moisture in the room in which it is installed. Ensure that the kitchen is well ventilated: keep natural ventilation holes open or install a mechanical ventilation device, (mechanical extractor hood). Prolonged intensive use of the appliance may call for additional ventilation, for example opening a window, or more effective ventilation, for example increasing the level of mechanical ventilation where present. For more detail see the Installation Instructions.

### **OVEN DOES NOT WORK AT ALL**

First, when the oven is equipped with timer, check appliance is not programmed to turn on later. If it is, turn to manual setting (i.e. hand symbol). If the button or scale on the timer remains in the automatic position after use, the power supply to the oven will be interrupted. Also, check your appliance is switched on at the mains. Next check for an unexpected power strike by switching on adjacent lights etc. Finally, check fuses and plug wiring. If all these prove satisfactory, call engineer.

### **LIGHT BULB DOESN'T COME ON**

Check bulb for looseness or burned out bulb.

**Note:** bulb replacement is not covered by your guarantee.

### **SMOKE COMING FROM OVEN**

If oven is still relatively new, this problem is invariably due to protective oil on elements. Otherwise, the answer may be oil or fat which has become deposited on the elements during cooking. In either event, continued use should burn away the residues. On future occasions, try to shield food with foil or keep it further away from element, particularly when grilling.

### **CLOCK/TIMER DOES NOT WORK**

Check to be sure range cord is plugged into outlet completely. Check for a blown fuse or tripped circuit breaker. Check for power outage. Check step by step operating instructions on previous pages.

**If, after checking through this section, you cannot resolve your problem please call the number on the data plate fixed to the front cover of these instructions for service and spare parts.**

**When ordering please quote the appliance name, the colour variant and serial number.**

**This information can be found on the data plate sealed inside the front appliance drawer.**

### Maintenance schedule:

To ensure the appliance continues to operate at peak performance, we recommend a routine service call every 2 years for the life of the appliance.





Worldwide Appliances Pty Limited  
A.B.N. 45868077422

Office:  
48-50 Moore Street, Leichhardt N.S.W 2040  
Post:  
Locked Bag 3000, Annandale, N.S.W 2038  
P: 1300 694 583

## WARRANTY REGISTRATION

Your ongoing satisfaction with your artusi product is important to us. We ask that you complete the enclosed Warranty Registration Card and return it to us so that we have a record of the artusi product purchased by you.

## PRIVACY

Worldwide Appliances respects your privacy and is committed to handling your personal information in accordance with the National Privacy Principles and the Privacy Act 1988 (Cth). A copy of the Worldwide Appliances Privacy Policy is available at [www.artusi.com.au](http://www.artusi.com.au). Worldwide Appliances will not disclose any personal information set out in the Warranty Registration Card ("Personal Information") without your consent unless required by:

1. law;
2. any Worldwide Appliances related company;
3. any service provider which provide services to artusi or assist artusi in providing services (including repair and warranty services) to customers. Our purpose in collecting the Personal Information is to keep a record of the artusi product purchased by you, in order to provide a better warranty service to you in the unlikely event that there is a problem with your artusi product. Worldwide Appliances may contact you at any one or more of the address, email address or telephone numbers set out in the Warranty Registration Card. Please contact artusi on 1300 694 583 should you not wish to be contacted by Worldwide Appliances.

## WARRANTY

### 1. Warranty

Worldwide Appliances warrants that each artusi product will remain, for a period of either 12 months or 24 months of warranty. All Warranties are valid from the original date of purchase, And warranty claims must be accompanied by the proof of purchase.

24 months warranty products:

All Built-in Appliances – Limited to Ovens, Gas, Induction and Electric Cooktops, and All Rangehoods

Freestanding Cookers - Gas and Electric Models (900mm Width)

Dishwashers - Freestanding, Fully Integrated, Semi Integrated and built-in

12 months warranty products:

Freestanding Cookers - Gas and Electric Models in 50cm, 54cm and 60cm Widths

Portable Appliances\* – Benchtop Models and Portable Gas Models

### 2. What is not Covered by the Warranty.

The Warranty does not apply if an artusi product is defective by a factor other than a defect arising in the manufacture of the artusi product, including but not limited to:

- (a) damage through misuse (including failure to maintain, service or use with proper care), neglect, accident or ordinary wear and tear (including deterioration of parts and accessories and glass breakage);
  - (b) use for purpose for which the artusi product was not sold or designed;
  - (c) use or installation which is not in accordance with any specified instructions for use or installation;
  - (d) use or operation after a defect has occurred or been discovered;
  - (e) damage through freight, transportation or handling in transit (other than when Worldwide Appliances is responsible);
  - (f) damage through exposure to chemicals, dusts, residues, excessive voltage, heat, atmospheric conditions or other forces or environmental factors outside the control of Worldwide Appliances;
  - (g) repair, modification or tampering by the purchaser or any person other than Worldwide Appliances, an employee of Worldwide Appliances or an authorised artusi service contractor\*;
  - (h) use of parts, components or accessories which have not been supplied or specifically approved by artusi.
  - (i) damage to surface coatings caused by cleaning or maintenance using products not recommended in the artusi product handbook provided to the purchaser upon purchase of the artusi product;
  - (j) damage to the base of an electric oven due to items having been placed on the base of the oven cavity or covering the base, such as aluminium foil (this impedes the transfer of heat from the element to the oven cavity and can result in irreparable damage); or
  - (k) damages, dents or other cosmetic imperfections not affecting the performance of the artusi in respect of an artusi product purchased as a "factory second" or from display
- The Warranty does not extend to light globes used in artusi products.

### 3. Domestic Use

Each artusi product is made for domestic use. This Warranty may not extend to artusi products used for commercial purposes.

**Continued over...**

#### 4. Time for Claim under the Warranty

You must make any claim under this Warranty within twenty eight (28) days after the occurrence of an event which gives rise to a claim pursuant to the Warranty, by booking a service call on the telephone number below.

#### 5. Proof of Purchase

Customers must retain proof of purchase in order to be eligible to make a warranty claim in respect of an artusi product.

#### 6. Claiming under the Warranty

Customers will bear the cost of claiming under this Warranty unless Worldwide Appliances determines the expenses are reasonable, in which case the customer must claim those expenses by providing written evidence of each expense to Worldwide Appliances at the address on the Warranty Registration Card.

#### 7. Statutory Rights

(a) These terms and conditions do not affect your statutory rights.

(b) The limitations on the Warranty set out in this document do not exclude or limit the application of the consumer guarantees set out in the Act or any other equivalent or corresponding legislation in the relevant jurisdiction where to do so would:

(i) contravene the law of the relevant jurisdiction; or

(ii) cause any part of the Warranty to be void.

(c) Worldwide Appliances excludes indirect or consequential loss of any kind (including, without limitation, loss of use of the artusi product) and (other than expressly provided for in these terms and conditions) subject to all terms, conditions and warranties implied by custom, the general law, the Act or other statute.

(d) The liability of Worldwide Appliances to you

for a breach of any express or non-excludable implied term, condition or warranty is limited at the option of Worldwide Appliances to:

(i) replacing or repairing the defective part of the artusi product;

(ii) paying the cost of replacing or repairing the defective part of the artusi product;

(iii) replacing the artusi product; or

(iv) paying the cost of replacing the artusi product.

(e) Our goods come with guarantees that cannot be excluded under the Australian Consumer Law. You are entitled to a replacement or refund for a major failure and for compensation for any other reasonably foreseeable loss or damage. You are also entitled to have the goods repaired or replaced if the goods fail to be of acceptable quality and the failure does not amount to a major failure.

#### 8. Defects

Any part of an artusi product deemed to be defective and replaced by Worldwide Appliances is the property of Worldwide Appliances. Worldwide Appliances reserves the right to inspect and test artusi products in order to determine the extent of any defect and the validity of a claim under the Warranty.

\*To locate your closest artusi authorised service agent please contact us on 1300 652 100 or visit [www.artusi.com.au](http://www.artusi.com.au)

ALL SERVICE CALLS MUST BE BOOKED THROUGH AN AUTHORISED DEALER OR WARRANTY DEPARTMENT ON 1300 652 100 OR [stokesaps.com.au/artusi-service](http://stokesaps.com.au/artusi-service)

01032014



Warranty Card tear off

WARRANTY REGISTRATION CARD  
01052013

Please complete and send to ARTUSI at: REPLY PAID 83617  
LEICHHARDT NSW 2040

Last Name:		First Name:	
Address:			
State:	Postcode:	Email:	
Home Phone:		Mobile:	
Purchase Date:    /    /		(Please attach proof of purchase to validate warranty)	

MODEL NUMBER	SERIAL NUMBER (if you cannot locate the serial number please call ARTUSI on 1300 694 583)
1	
2	
3	
4	

01032014





#### DISCLAIMER

Worldwide Appliances PTY LTD, trading as ARTUSI, is continually seeking ways to improve the design specifications, aesthetics and production techniques of its products. As a result alterations to our products and designs take place continually. Whilst every effort is made to produce information and literature that is up to date, this brochure should not be regarded as an infallible guide to the current specifications, nor does it constitute an offer for the sale of any particular product. Product dimensions indicated in our literature is indicative only. Actual product only should be used to define dimension cutouts. Distributors, and retailers are not agents of ARTUSI and are not authorised to bind ARTUSI by any express or implied undertaking or representation.

ARTUSI OFFICES ARE OPEN DAILY FROM 9AM-5PM AND SATURDAYS 10AM-4PM

NSW & ACT (HEAD OFFICE)  
48-50 MOORE STREET  
LEICHHARDT  
F 02 8569 4699

VIC, TAS & SA  
1211 TOORAK ROAD  
CAMBERWELL  
F 03 9809 2155

QLD  
1/42 CAVENDISH ROAD  
COORPAROO  
F 07 3397 0850

WA & NT  
UNIT 10/55 HOWE STREET  
OSBORNE PARK  
F 08 9201 9188

NZ  
PO BOX 11160  
SOCKBURN CHRISTCHURCH  
F 03 344 5906

P: 1300 649 583

ARTUSI.COM.AU