



# APPLIANCES FOR LIVING



**ARTUSI**  
THE ART OF LIVING

**CACCIA**  
**OPERATION MANUAL**

Congratulations, you are now the proud owner of an ARTUSI cooking appliance. Thank you for purchasing ARTUSI and welcome to the ARTUSI Family.

This instruction manual has been specially created to inform you of the full range of features your ARTUSI appliance has to offer and serves as an introduction to getting the very best out of your ARTUSI appliance.

We present detailed information on each of the features your ARTUSI appliance consists of. Once you have read this section you will be able to choose the most appropriate settings for your appliance when cooking different types of food.

We ask you to read the instructions in this booklet very carefully as this will allow you to get the best results from using your appliance. KEEP THE DOCUMENTATION OF THIS PRODUCT FOR FUTURE REFERENCE.

TO REGISTER YOUR PRODUCT WITH ARTUSI, PLEASE FILL OUT THE WARRANTY CARD AT THE END OF THIS BOOKLET AND POST IT TO: **REPLY PAID 83617**  
**LEICHHARDT NSW 2040**

Dear Artusi Customer, please read this user manual carefully before using the product and, keep it permanently at your disposal.

Note: This user manual is prepared for more than one model. Some of the features specified in this Manual may not be available on your appliance.

All our appliances are only for domestic use, not for commercial use. Products marked with (\*) are optional.

“THIS APPLIANCE SHALL BE INSTALLED IN ACCORDANCE WITH THE REGULATIONS FORCE AND ONLY USED IN A WELL VENTILATED SPACE. READ THE INSTRUCTIONS BEFORE INSTALLING OR USING THIS APPLIANCE”

“Conforms with the WEEE Regulations.”



# BUILT-IN CERAMIC HOB

## INSTALLATION AND OPERATION MANUAL

# CACC1A

### Please read the instruction manual carefully before operating your new hob.

Dear Owner: Thank you for purchasing our cooktop designed to give you many years of cooking pleasure. Before using your new appliance please read the user manual carefully and keep it in a safe place for future reference.

**THIS APPLIANCE MUST ONLY BE INSTALLED BY A QUALIFIED PERSON USING THE INSTRUCTIONS PROVIDED. THE MANUFACTURER DECLINES ALL RESPONSIBILITY FOR IMPROPER INSTALLATION THAT MAY HARM PERSONS AND ANIMALS OR CAUSE DAMAGE TO PROPERTY. THE APPLIANCE MUST ONLY BE USED FOR THE PURPOSE FOR WHICH IT WAS DESIGNED. ANY OTHER USE (e.g. HEATING ROOMS) IS CONSIDERED TO BE IMPROPER AND MANUFACTURER DECLINES ALL RESPONSIBILITY FOR DAMAGE RESULTING FROM IMPROPER AND/ OR IRRESPONSIBLE USE.**

V20190830

Cod: 0070303178

### Operation of the hob heating zones

To save energy and to have a longer life of the ceramic hob, we advise using pots and pans with flat bottoms and with a diameter not less than the diameter of the heating zones. Care must be taken that fluids do not spill on the ceramic hob. Never leave the heating zones on without pans or with empty pans on them. Never use the heating zones to warm plates. Switch on the heating zones after having put the pans on them. CAUTION: when switched off the heating zones remain hot to warm for some time so do not touch. Switch off the heating zones before removing the pans.

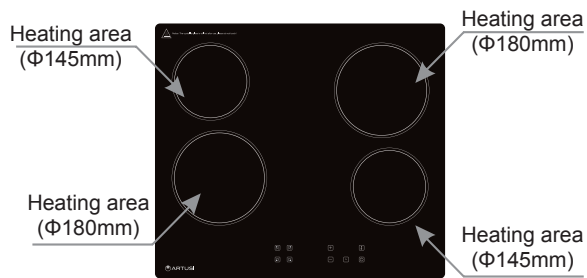

### Using the Touch Controls

- The controls respond to touch, so you don't need to apply any pressure
- Use the ball of your finger, not its tip.
- You will hear a beep each time a touch is registered.
- Make sure the controls are always clean, dry, and that there is no object (e.g. a utensil or a cloth) covering them. Even a thin film of water may make the controls difficult to operate.

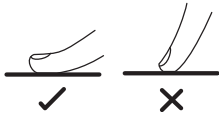

### Touch control

- All operations are performed by means of the touch controls on the control panel.
- Each touch control has a corresponding visual display (indicator light).
- You will hear a beep each time a touch is registered.

### Switching on the ceramic hob

- Press the ON/OFF button (fig. 1) to switch on the appliance.
- The hob will beep once and all cooking zone indicators will light up briefly indicating that the hob has entered stand-by mode.

**Note:** Make the next step within one minute otherwise the hob will automatically shut down.

### Switching on a cooking zone and setting a power level

- Press the cooking zone select button (fig. 2) for the zone you want to use.
- Select the heat level required (1-9) by using the up and down buttons (fig. 3). By holding down either of these buttons, the value on the heat level display will adjust up or down.

**Note:** when the power level displayed is 0, press the down button and the power will set to 9

### Switching off the ceramic hob

- Press the ON/OFF button, the hob will switch off. It is possible to turn the hob off at any time by pressing the ON/OFF button.
  - Press the up or down buttons to 0, then hob will switch off.
- After a zone is switched off, the corresponding heat level display will show a flashing letter "H" (Hot). This means that the temperature of the zone is above 60°C and is still high enough to cause injury.
- When the temperature of the zone falls below 60°C the letter "H" will go out. It is still possible to burn yourself on a hob zone, even when its temperature has dropped below 60°C.
- IMPORTANT:** The residual heat indicator will disappear if the power supply to the product is cut.

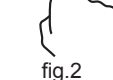

### IMPORTANT NOTICE

Please register your warranty card. Return the enclosed warranty card dated and signed. The Manufacturer shall not be held responsible for any inaccuracies in this handbook due to printing or transcription errors. The designs in the images and figures are purely indicative. The Manufacturer reserves the right to make any modifications to the products as may be considered necessary or useful or in the interests of the user, without jeopardizing the main functional and safety features of the product.

### SAFETY WARNING

- Inspect the built-in ceramic hob carefully after opening the package. When there are any problems please refer to the supplier.
  - Dispose of packaging materials (plastic bag, foam, nails, carton) carefully. Avoid a place where children can easily access. Please dispose of packaging in an environmentally friendly manner.
  - Never attempt to change the wiring under any circumstances.
  - Dispose of the appliance in an environmentally friendly manner.
  - Replace damaged power cords by the manufacturer, its service agent or similarly qualified persons in order to avoid a hazard.
  - The appliance is not to be used by persons (including children) with reduced physical, sensory or mental capabilities, or a lack of experience and knowledge. All such users must be given instruction and kept under supervision. Always supervise children and never allow them to play with the appliance.
  - Never stare at the hob elements when the appliance is working. It may damage your eyes.
  - Avoid burns: young children should be kept away as accessible parts become hot during use
  - WARNING:** If the hob surface is cracked, switch off the appliance to avoid the possibility of electric shock as hob glass-ceramic protect users from live electric parts.
  - Never use a steam cleaner on the hob.
  - Do not place metallic objects such as knives, forks, spoons and lids on the hob surface since they can get hot.
  - CAUTION:** The surface temperature exceeds 95°C. To avoid a hazard under bench access must be restricted. Refer to the installation instructions.
  - WARNING:** The appliance and its accessible parts become hot during use. Care should be taken to avoid touching heating elements.
  - Do not operate the appliance with an external timer or separate remote-control system.
  - WARNING:** Use only hob guards designed by the manufacturer of the cooking appliance or indicated by the manufacturer of the appliance in the instructions for use as suitable or hob guards incorporated in the appliance. The use of inappropriate guards can cause accidents.
  - Do not touch the built-in ceramic hob with wet hands or while standing in water with bare feet.
  - Do not operate the built-in electric hob when you are bare footed.
  - Always disconnect the power supply before you do any maintenance and cleaning.
- When the built-in ceramic hob is working, the temperature of the electric hob and the ambient temperatures become higher, so do not touch it and keep children away.
- The built-in ceramic hob must be built into a heat resistant cabinet.
  - NOTE:** Some smoke may occur when the hob is first used. Leave the hob on for a short period to burn off excess sealants etc. used in the manufacturing process.

**Danger of fire: Do not store items on the cooking surfaces.**

**CAUTION: Never leave any cooking food unattended. Spills, overflows, burnt food and/or fire may result.**

**WARNING: Unattended cooking using fat or oil can be dangerous and may result in a fire. In the event of a fire: Switch off the appliance and then cover the flame with a lid or a fire blanket. NEVER try to extinguish a fire with water.**

### Locking the ceramic hob

To lock the ceramic hob, press the safety lock button (fig. 4) while the appliance is switched on. With the safety lock activated, all buttons on the control panel will be disabled, except the ON/OFF button. To disable the safety lock feature, press the safety lock button again. Then adjust the heat level of any zone on the hob.



fig.4

When the hob is in the lock mode, all the controls are disabled except the ON/OFF. You can always turn the induction hob off with the ON/OFF in an emergency.

### Timer

- Your hob has a timer which you can set (from 1 to 99 minutes) for each cooking zone. At the end of the countdown period, a buzzer will sound and the cooking zone will be switched off.
- Select the cooking zone (fig. 2) and heat level (fig. 3).
- Press the timer button (fig. 5), and then use the up and down buttons to set the countdown time.
- Each time the timer up or down button is pressed, the timer display will increase or decrease in 1 minute increments.



fig.5

### Safety cut-off

- When one or more of the cooking zones are accidentally left on, a safety cut-off will activate after a certain period of time. The length of time depends on the set power level for that zone. The table below gives the time limits for each power level.
- When more than one zone is operating and one of the zones reaches its safety cut-off point, only the zone that has reached its safety cut-off point will switch off.

Power level	1	2	3	4	5	6	7	8	9
Time limit (hours)	6	6	5	5	4	1.5	1.5	1.5	1.5

### Technical Data

Model	Power Supply	Power(W)		Size (mm)	Built-in Hole Size (mm)
		(145mm)	(180mm)		
CACC1A	AC 220-240V 50-60Hz	1200W	1800W	580X510X68	564(L)X494(W)

### Utensils

Use pans with flat bottoms. Uneven or thin bottoms will waste energy and cooking times will be slow. Use pans slightly larger than the cooking zones. Smaller pans will waste energy. Do not use oversized pans. More than 50mm oversize can overheat cooktop components and can cause fine cracks in the enamel hob that will trap dirt. Use only dry utensils. Do not place wet or steamy parts (eg. lids) on the hotplates. Do not use pots and pans that are unsteady and likely to rock or overbalance. Do not operate the cooktop without pots or pans on the cooking zones.

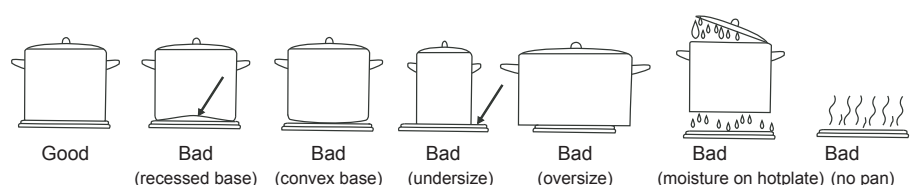

Good (recessed base) Bad (convex base) Bad (undersize) Bad (oversize) Bad (moisture on hotplate) (no pan)

## Cleaning

Turn off the main power to the hob before carrying out any maintenance and wait for it to cool down. Use lukewarm water and detergents to clean enameled elements. Never use abrasive products. Clean tough stains using non-abrasive detergents or warm vinegar. Use sponges or a damp cloth to clean the hob. Remove cleaning liquid from the glass worktop with a damp cloth and dry using a soft cloth. Note: excess water can damage the electric elements. Clean the electric tops using a damp cloth, then lightly oil the top when it is still warm. Only licensed repairers should service and repair the appliance

## Installation

### Electrical connection

Appliances with three-pole cable are set up for operation with alternating current at the voltage and frequency indicated on the rating plate. Look at the connection wiring diagram. The earth conductor is yellow/green. The connection to the electricity supply must be made by a qualified person and following the regulations. When the appliance is to be installed above a built-in oven, the two appliances must be connected separately to make it easier to take the appliances out and for electrical safety. The supply cable must be so positioned that no point can reach a temperature 50° C higher than ambient temperature. Check that the supply system has an effective earth connection and meets the standards and that the breaker can be reached easily when the appliance is installed. When a cable is damaged or must be replaced, the operation must be carried out by a service agent or a suitably qualified professional. When the appliance is being connected directly to the mains, an omnipolar circuit breaker must be installed with a minimum opening of 3mm between contacts. The installer must ensure that the correct electrical connection has been made and that it is compliant with all applicable standards and safety regulations. The cable must not be bent or compressed. The cable must be checked regularly and replaced by authorised technicians only.

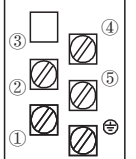
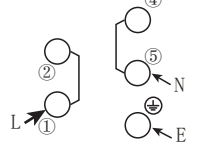
<p><b>CONNECTION DIAGRAM</b> Caution! Voltage of heating elements 220-240V Caution! In the event of any connection the safety Wire must be connected to the ⊕ E terminal.</p>		<p>Recommended type of connection lead <b>H07RN-F3G4</b></p>
<p>For 220-240V earthed one-phase connection, bridges connect L①-② terminals and N④-⑤ terminals, safety wire to ⊕</p>		



**WARNING**  
Close the cable clamp after making the electrical connection. Close the terminal board cover by twisting it down.

TERMINAL BOARD

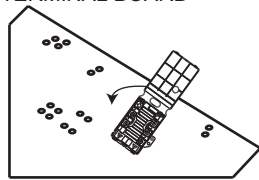

## TECHNICAL INFORMATION FOR INSTALLATION PERSONNEL

This appliance must be installed only by authorised personnel and in accordance with the regulations of electricity authorities. The wall and bench surfaces must be capable of sustaining temperatures of 95 degrees Celsius. All laminates, fixing adhesive and surfacing materials should be certified suitable for this temperature. Do not install it in areas with combustible materials.

According to the pictures, cut the hole in bench and place the built-in electric hob in it. Your hob can be fitted to any worktop with a thickness of 40 to 50 mm.

Unit:mm

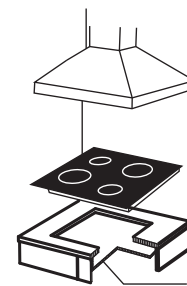
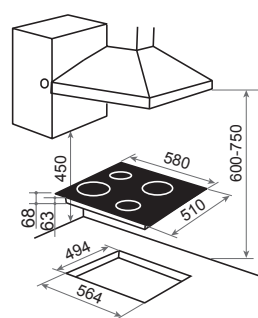

Recommended installation

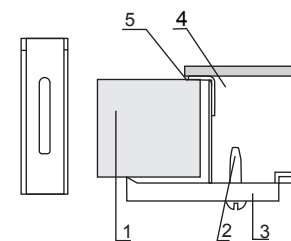
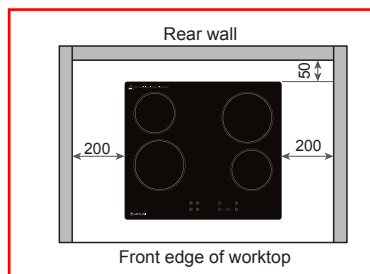
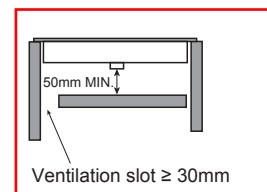

1-worktop  
2-screw  
3-bracket  
4-hob  
5-hob seal

## Inserting and fixing the hob

Before inserting the hob into the work surface, place the adhesive seal "s" around the underside edge of the hob. It is important to fix this gasket evenly without gaps or overlap to prevent liquids from seeping underneath the hob.

1. Place the gasket around the bottom edge of the hobs as shown in the illustration overleaf.
2. Place the hob in the installation opening and push it down so that the hob is resting firmly on the cabinet.
3. Secure the hob in position using the fixing brackets supplied.

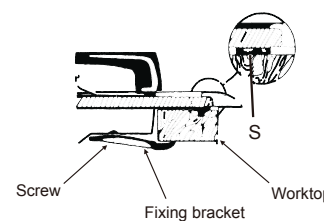

## Fitting guidelines

Secure the hob to the underside of the worktop using the fixings provided. Screw one end of the bracket into the pre-drilled holes in the underside of the hob. The other end of the bracket should be located underneath the worktop to secure the hob in position.  
Note 1: Fire resistant material (e.g. ceramic tiles) are required to 450mm above burner top if wall or vertical structures are not permitted within 200mm from burner.  
Note 2: No overhanging surface or rangehood / exhaust system are permitted within 600mm above cooktop.  
Note 3: Leave at least 50mm clearance between the base of the appliance and a combustible surface. Never leave the packing components (plastic bags, nails, foamed polystyrene, etc.) within the reach of the children since they are a source of potential danger. The hob has a special seal which prevents liquid from entering the cabinet. Follow these instructions in order to correctly apply it.

**Seal:**  
Detach the seal/s from their backing, ensure that the transparent protection still adheres to the seal itself. Turn over the hob and correctly position seal under the edge of the hob, so that the outer part of the seal perfectly matches the outer edge of the hob. Press the seal firmly in place to fix the seal to the hob.

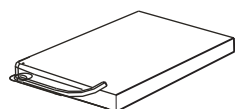

Scraper for cleaning the hob

## CLEANING AND MAINTENANCE

- Do not use cleaning products containing abrasive materials for the cleaning and maintenance of the glass. e.g. scouring powders containing an abrasive, abrasive compounds, abrasive stones, pumice stones, wire brushes and so on. They may scratch the hob surface, causing irreversible damage.  
- Large spillages that are firmly burnt onto the hob can be removed using a special scraper; be careful not to damage the ceramic hob surface when doing this.

**Caution!** The scraper sharp blade should always be protected by adjusting the cover (just push it with your thumb). Injuries are possible so be careful when using this instrument, keep it out of reach of children. Appropriate light cleaning products are recommended e.g. any kind of liquid detergents. Alternatively a solution of warm water with a little dishwashing liquid or cleaning products for stainless steel sinks can be used.

## MALFUNCTION ELIMINATION

PROBLEM	SOLUTION
Hob doesn't work	<ul style="list-style-type: none"> <li>•Check the power connection</li> <li>•Check the safety cutoff switch is OFF</li> <li>•Check the fuse and the mains current limit</li> </ul>
There is some smoke when the hob is working	<ul style="list-style-type: none"> <li>•It is normal the first time use.</li> <li>•Clean around the electric hob and the cooking zones</li> </ul>
The wire/s are damaged	<ul style="list-style-type: none"> <li>•Contact the nearest maintenance centre for service/ repair.</li> </ul>



By ensuring that this appliance is disposed of correctly, you will help prevent any possible harm to the environment and to human health which might otherwise be caused if disposed of in the wrong way.

The symbol on the product indicates that it may not be treated as normal household waste. It should be taken to a collection point for the recycling of electrical and electronic goods.

For further information regarding the treatment, recovery and recycling of this product, please contact your local council, household waste disposal service or the shop where you purchased the product.

Product Information	Symbol	Value	Unit
Model Identification	--	CACC1A	
Type of Hob	--	Built-in ceramic hob	
Number of cooking zones	--	4	
Heating Technology (cooking areas, radiant cooking zones, solid plates)	--	Radiant cooking zones	
Diameter of useful surface area per electric heated cooking zone (rounded to the nearest 5mm)	∅	Big ring: 180mm Small ring: 145mm	MM
Energy consumption cooking zone area calculated per kg	EC	Big ring: 194 Small ring: 187	Wh/kg
Energy consumption calculated per kg	EC	189	Wh/kg



Worldwide Appliances Pty Limited  
A.B.N. 45868077422

Office:

48-50 Moore Street, Leichhardt N.S.W 2040

Post:

Locked Bag 3000, Annandale, N.S.W 2038

P: 1300 694 583

## WARRANTY REGISTRATION

Your ongoing satisfaction with your artusi product is important to us. We ask that you complete the enclosed Warranty Registration Card and return it to us so that we have a record of the artusi product purchased by you.

## PRIVACY

Worldwide Appliances respects your privacy and is committed to handling your personal information in accordance with the National Privacy Principles and the Privacy Act 1988 (Cth). A copy of the Worldwide Appliances Privacy Policy is available at [www.artusi.com.au](http://www.artusi.com.au). Worldwide Appliances will not disclose any personal information set out in the Warranty Registration Card ("Personal Information") without your consent unless required by:

1. law;
2. any Worldwide Appliances related company;
3. any service provider which provide services to artusi or assist artusi in providing services (including repair and warranty services) to customers. Our purpose in collecting the Personal Information is

to keep a record of the artusi product purchased by you, in order to provide a better warranty service to you in the unlikely event that there is a problem with your artusi product. Worldwide Appliances may contact you at any one or more of the address, email address or telephone numbers set out in the Warranty Registration Card. Please contact artusi on 1300 694 583 should you not wish to be contacted by Worldwide Appliances.

## WARRANTY

### 1. Warranty

Worldwide Appliances warrants that each artusi product will remain, for a period of either 12 months or 24 months of warranty. All Warranties are valid from the original date of purchase, And warranty claims must be accompanied by the proof of purchase.

24 months warranty products:

All Built-in Appliances – Limited to Ovens, Gas, Induction and Electric Cooktops, and All Rangehoods

Freestanding Cookers - Gas and Electric Models (900mm Width)

Dishwashers - Freestanding, Fully Integrated, Semi Integrated and built-in

12 months warranty products:

Freestanding Cookers - Gas and Electric Models in 50cm, 54cm and 60cm Widths

Portable Appliances\* – Benchtop Models and Portable Gas Models

### 2. What is not Covered by the Warranty.

The Warranty does not apply if an artusi product is defective by a factor other than a defect arising in the manufacture of the artusi product, including but not limited to:

- (a) damage through misuse (including failure to maintain, service or use with proper care), neglect, accident or ordinary wear and tear (including deterioration of parts and accessories and glass breakage);
  - (b) use for purpose for which the artusi product was not sold or designed;
  - (c) use or installation which is not in accordance with any specified instructions for use or installation;
  - (d) use or operation after a defect has occurred or been discovered;
  - (e) damage through freight, transportation or handling in transit (other than when Worldwide Appliances is responsible);
  - (f) damage through exposure to chemicals, dusts, residues, excessive voltage, heat, atmospheric conditions or other forces or environmental factors outside the control of Worldwide Appliances;
  - (g) repair, modification or tampering by the purchaser or any person other than Worldwide Appliances, an employee of Worldwide Appliances or an authorised artusi service contractor\*;
  - (h) use of parts, components or accessories which have not been supplied or specifically approved by artusi.
  - (i) damage to surface coatings caused by cleaning or maintenance using products not recommended in the artusi product handbook provided to the purchaser upon purchase of the artusi product;
  - (j) damage to the base of an electric oven due to items having been placed on the base of the oven cavity or covering the base, such as aluminium foil (this impedes the transfer of heat from the element to the oven cavity and can result in irreparable damage); or
  - (k) damages, dents or other cosmetic imperfections not affecting the performance of the artusi in respect of an artusi product purchased as a "factory second" or from display
- The Warranty does not extend to light globes used in artusi products.

### 3. Domestic Use

Each artusi product is made for domestic use. This Warranty may not extend to artusi products used for commercial purposes.

**Continued over...**



#### 4. Time for Claim under the Warranty

You must make any claim under this Warranty within twenty eight (28) days after the occurrence of an event which gives rise to a claim pursuant to the Warranty, by booking a service call on the telephone number below.

#### 5. Proof of Purchase

Customers must retain proof of purchase in order to be eligible to make a warranty claim in respect of an artusi product.

#### 6. Claiming under the Warranty

Customers will bear the cost of claiming under this Warranty unless Worldwide Appliances determines the expenses are reasonable, in which case the customer must claim those expenses by providing written evidence of each expense to Worldwide Appliances at the address on the Warranty Registration Card.

#### 7. Statutory Rights

(a) These terms and conditions do not affect your statutory rights.

(b) The limitations on the Warranty set out in this document do not exclude or limit the application of the consumer guarantees set out in the Act or any other equivalent or corresponding legislation in the relevant jurisdiction where to do so would:

(i) contravene the law of the relevant jurisdiction; or

(ii) cause any part of the Warranty to be void.

(c) Worldwide Appliances excludes indirect or consequential loss of any kind (including, without limitation, loss of use of the artusi product) and (other than expressly provided for in these terms and conditions) subject to all terms, conditions and warranties implied by custom, the general law, the Act or other statute.

(d) The liability of Worldwide Appliances to you

for a breach of any express or non-excludable implied term, condition or warranty is limited at the option of Worldwide Appliances to:

(i) replacing or repairing the defective part of the artusi product;

(ii) paying the cost of replacing or repairing the defective part of the artusi product;

(iii) replacing the artusi product; or

(iv) paying the cost of replacing the artusi product.

(e) Our goods come with guarantees that cannot be excluded under the Australian Consumer Law. You are entitled to a replacement or refund for a major failure and for compensation for any other reasonably foreseeable loss or damage. You are also entitled to have the goods repaired or replaced if the goods fail to be of acceptable quality and the failure does not amount to a major failure.

#### 8. Defects

Any part of an artusi product deemed to be defective and replaced by Worldwide Appliances is the property of Worldwide Appliances. Worldwide Appliances reserves the right to inspect and test artusi products in order to determine the extent of any defect and the validity of a claim under the Warranty.

\*To locate your closest artusi authorised service agent please contact us on 1300 652 100 or visit [www.artusi.com.au](http://www.artusi.com.au)

ALL SERVICE CALLS MUST BE BOOKED THROUGH AN AUTHORISED DEALER OR WARRANTY DEPARTMENT ON 1300 652 100 OR [stokesaps.com.au/artusi-service](http://stokesaps.com.au/artusi-service)

01032014



Warranty Card tear off

WARRANTY REGISTRATION CARD  
01052013

Please complete and send to ARTUSI at: REPLY PAID 83617  
LEICHHARDT NSW 2040

Last Name:		First Name:	
Address:			
State:	Postcode:	Email:	
Home Phone:		Mobile:	
Purchase Date:    /    /		(Please attach proof of purchase to validate warranty)	

MODEL NUMBER	SERIAL NUMBER (if you cannot locate the serial number please call ARTUSI on 1300 694 583)
1	
2	
3	
4	

01032014





#### DISCLAIMER

Worldwide Appliances PTY LTD, trading as ARTUSI, is continually seeking ways to improve the design specifications, aesthetics and production techniques of its products. As a result alterations to our products and designs take place continually. Whilst every effort is made to produce information and literature that is up to date, this brochure should not be regarded as an infallible guide to the current specifications, nor does it constitute an offer for the sale of any particular product. Product dimensions indicated in our literature is indicative only. Actual product only should be used to define dimension cutouts. Distributors, and retailers are not agents of ARTUSI and are not authorised to bind ARTUSI by any express or implied undertaking or representation.

ARTUSI OFFICES ARE OPEN DAILY FROM 9AM-5PM AND SATURDAYS 10AM-4PM

NSW & ACT (HEAD OFFICE)  
48-50 MOORE STREET  
LEICHHARDT  
F 02 8569 4699

VIC, TAS & SA  
1211 TOORAK ROAD  
CAMBERWELL  
F 03 9809 2155

QLD  
1/42 CAVENDISH ROAD  
COORPAROO  
F 07 3397 0850

WA & NT  
UNIT 10/55 HOWE STREET  
OSBORNE PARK  
F 08 9201 9188

NZ  
PO BOX 11160  
SOCKBURN CHRISTCHURCH  
F 03 344 5906

P: 1300 649 583

ARTUSI.COM.AU